

Sturminster Marshall Neighbourhood Plan 2023 - 2033

Prepared by Sturminster Marshall
Neighbourhood Plan Steering Group
for Sturminster Marshall Parish Council
Pre-Submission Draft: June 2023

1. CONTENTS

2. Foreword	5
3. An Overview of the Parish	6
3.1 Location	6
3.2 A brief history of the parish	7
3.3 The wider environment	7
3.4 Today's population, Housing and local businesses	7
The Local Plan context	8
East Dorset and Christchurch Local Plan Part 1 - Core Strategy, adopted April 2014	8
East Dorset Local Plan Options (consultation draft), Published July 2018	8
Dorset Council Local Plan (Options Consultation Draft), Published January 2021	9
4. About this Neighbourhood Plan	10
4.1 What is neighbourhood planning?	10
4.2 What is in it?	10
Key aspects of the Plan	10
4.3 How was it prepared?	11
4.4 What Stage has the Plan reached?	11
4.5 How long will the plan last?	12
5. Vision and Objectives	13
5.1 Background	13
5.2 Vision	13
5.3 Objectives	14
Climate Change and Flood Risk	14
Natural Environment – Landscapes, Habitats and Wildlife	14
Built Environment – Heritage and Design	14
Homes and Businesses	14
Community Facilities	14
Traffic and Transport, Walking and Cycling	14
6. Climate Change and Flood Risk	15
6.1 Introduction	15
6.2 Sustainable Development Standards	16
6.3 Flood Risk	16
Flood-related pollution	18
Sustainable Urban Drainage systems (SUDS)	19
7. Natural Environment– Landscapes, Habitats and Wildlife	21
7.1 Introduction	21
7.2 Landscape character	23
7.3 Valued Walks and Views	24
7.4 Local Green Spaces	27
7.5 Habitats and wildlife	29
8. Built Environment – Heritage and Design	32
8.1 Heritage – protecting locally important features	32
8.2 Built Characteristics of Sturminster Marshall village	33
The Historic Core	34
The High Street	35
Bailie Gate Industrial Estate	37
Churchill Close	38

Station Road	40
Railway Drive	41
Blandford Road and Dullar Lane.....	42
8.3 Built Characteristics of the wider countryside and hamlets	43
Henbury	44
Jubilee Cross	45
Almer and Mapperton	47
8.4 Applying the design principles to development.....	48
Layout - Street / plot pattern, building line and orientation.....	48
Building form and scale	50
Boundary treatment and public realm	51
Materials and Architectural design	53
9. Homes and Businesses	56
9.1 How much housing is needed?.....	56
9.2 The type of housing needed	57
9.3 Potential Housing Sites.....	59
Green Belt Restrictions.....	59
Opportunities for more affordable housing.....	60
9.4 Employment and Business opportunities.....	60
10. Community Facilities	64
10.1 Existing Community Facilities	64
Shops and Retail	64
Social and Spiritual	65
Outdoor Sport and Recreation	66
Education.....	66
Healthcare	66
10.2 Future needs.....	66
11. Traffic, Transport, Walking & Cycling.....	69
11.1 Rights of Way, Walking & Cycling.....	69
Walking.....	69
Cycling.....	69
North Dorset Trailway	69
Solutions to be explored.....	70
11.2 Road Traffic and Highway safety	73
Solutions to be explored.....	74
12. Policies List.....	77
13. Appendix 1– Adopted Local Plan – key policies	78
14. Appendix 2 – List of supporting Evidence.....	80
15. Appendix 3 – LOCAL GREEN SPACES	81
16. Appendix 4– Wildlife and Habitats Data	116
16.1 Internationally Important Sites	116
16.2 Other Nationally Important Sites	117
16.3 Locally Important Sites	117
16.4 Protected Species	118
17. Appendix 5 – Non-Designated Heritage Assets	122
18. Appendix 6 – Indicative Housing Target assessment	128

18.1	Local need arising from within the village:.....	128
18.2	Past rates / take-up of development.....	129
18.3	Housing Target conclusions:.....	129
19.	Appendix 7 - public rights of way review	130

2. FOREWORD

Welcome to the Sturminster Marshall Neighbourhood Plan.

In this, the first Neighbourhood Plan for Sturminster Marshall (“the Plan”), we have used the provisions in the Localism Act to prepare a plan which should ensure the future of village and parish. The Localism Act (2012) seeks to shift power from central government into the hands of individuals, communities and councils, by giving them the right to shape their local areas through Neighbourhood Development Plans. It is vital therefore that for Sturminster Marshall we have a Plan which has the backing of the community to provide guidance when decisions are made about the future of our village and parish. This Plan builds on the Parish Plan Review 2011, The Christchurch and East Dorset Local Plan Part 1 - Core Strategy adopted in April 2014 and the wide range of documents produced by Dorset Council in the preparation of the draft Dorset Council Local Plan and other guidance covering the Plan area.

The policies, projects and actions identified in the Plan should support and encourage a community where people can lead active and fulfilled lives in the place where they live and work. Sturminster Marshall Parish Council will ‘champion’ and provide support and encouragement for these policies. We will also monitor the Plan’s progress to make sure that the local community is kept informed.

We should like to extend our sincere thanks to all those who have helped with the preparation of the Plan and I look forward to receiving the support of the community so that both Dorset Council and our Parish Council can put the Plan into action.

Hilary Palmer, Chair, Sturminster Marshall Parish Council

3. AN OVERVIEW OF THE PARISH

3.1 LOCATION

3.1.1 Sturminster Marshall lies to the west of Wimborne in eastern Dorset. The Neighbourhood Plan area follows the parish boundaries, and is approximately 20.85 square km¹ (2,085ha). The parish includes the main village of Sturminster Marshall with the smaller settlements of Almer and Mapperton to the West, in the Winterborne valley, Henbury to the southeast and Jubilee Cross on higher ground along the southern boundary. Newton Peveril, Moorcourt Farm and Field Dairy Farm/New Buildings form part of the predominantly agricultural fringe to the main village.



Map 1. Neighbourhood Plan Area Boundary

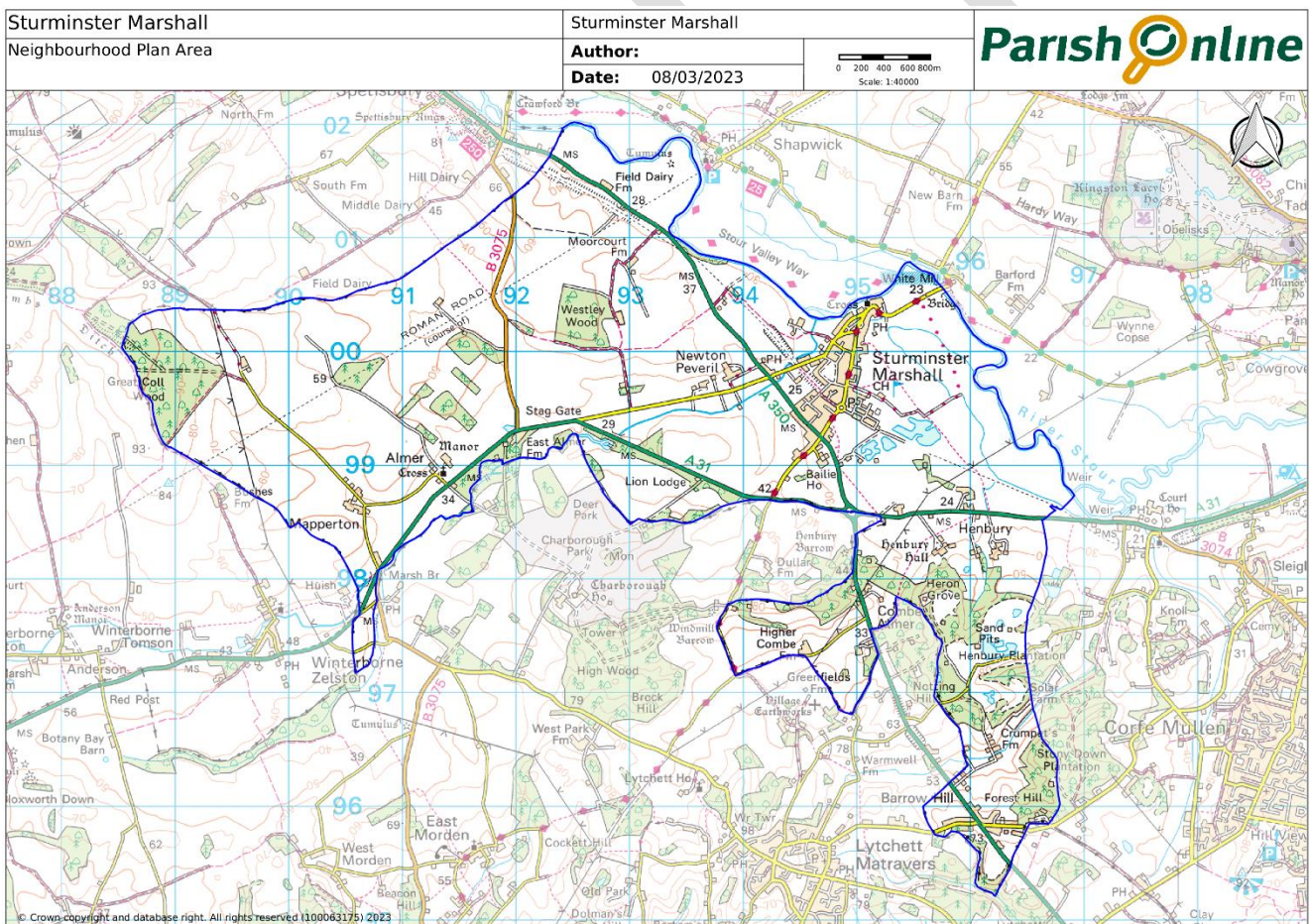

3.1.2 Two main roads intersect in the parish: the A31, which is a primary trunk route running East-West; and the A350 which connects the port of Poole northwards towards the M4 and the Midlands. Formerly, the Somerset and Dorset Railway line also ran through the village, with a station at Bailey Gate, and was influential in the development of Sturminster Marshall village.

¹ Office for National Statistics Local Area Report <https://www.nomisweb.co.uk/reports/localarea?compare=E04003382>

3.2 A BRIEF HISTORY OF THE PARISH

3.2.1 Whilst archaeology shows that people have lived in this area since Mesolithic times, the village of **Sturminster Marshall** is first mentioned in the Anglo-Saxon charter of 880AD. White Mill Bridge was built around 1175 and became a very important crossing point of the River Stour. For centuries the village was a farming community but in 1860 the Somerset and Dorset Railway arrived and the village extended along Station Road, diversifying its economic base. A milk processing factory and later a cheese factory were built close to the station, bringing industry to the area. On nearby low lying land, a watercress farm was established. With the closure of the railway in 1966, Sturminster Marshall's economy declined. The watercress farm ceased to operate shortly after, becoming a trout farm and then a site for gravel extraction. Milk processing ceased in 1978 and the cheese packing factory closed in 1989. The railway station and milk factory site is now the Bailie Gate Industrial Estate, and the watercress farm is now fishing lakes. Today the village is more of a dormitory settlement for people who work elsewhere.

3.2.2 In the nineteenth century **Henbury**, to the south of the main village above the main river valley was mainly parkland associated with two estates centred on Henbury House and Henbury Manor. Sand and gravel quarries were located to the south.

3.2.3 **Almer and Mapperton** are two rural hamlets largely sited within the Charborough (Drax) Estate. Both are designated conservation areas. The hamlet of Almer contains St Mary's Church (a building of outstanding architectural importance), the Elizabethan Almer Manor and farm buildings of West Almer Farm. The surrounding woodlands contribute to the setting of this hamlet, creating an element of enclosure in an otherwise open landscape. The hamlet of Mapperton is centred on Mapperton Farm and the Old Rectory, described in the Conservation Area Appraisal as an imposing Georgian house.

3.2.4 The southern part of the parish, known as **Jubilee Cross** is relatively modern with individually designed properties built after the Second World War, that are set back from the roads and surrounded by Green Belt. The area known as Crumpet's Drive includes prefabricated buildings, provided to house resettlement families. Surrounding the houses there are remnants of former sand and gravel workings and brick works.

3.3 THE WIDER ENVIRONMENT

3.3.1 Most of the parish lies within the Dorset Downs and Cranborne Chase National Character Area (NCA) whilst Jubilee Cross is in the Dorset Heaths NCA. The flat meandering Stour Valley, together with part of the South Blandford Downs, is designated locally as an Area of Great Landscape Value (AGLV) and forms part of the setting of the Cranborne Chase and West Wiltshire Downs AONB to the North. Although most of the land within the parish is arable or improved pasture, nevertheless, there are small pockets of semi-natural habitat which form an important part of the character of the area and link to the more highly valued wildlife sites nearby.

3.4 TODAY'S POPULATION, HOUSING AND LOCAL BUSINESSES

3.4.1 The 2021 census shows the population of the parish as 1971 people. Among those 16 years and older 937 were economically active and in employment.

Of those aged 16 to 74 in employment, the highest proportion, around 13.5% in each case, worked in manufacturing, the wholesale and retail trade (including motor vehicle repairs), or real estate, renting and business activities. 10.4% worked in health and social care, 9.3% in construction, 8.0% in finance and 7.6% in education. No other activity was carried out by more than 5.1% of the working population of the parish.

Changing patterns of distances travelled to work are shown by comparing 2021 census data with that for 2011 (with the caveat that the 2021 Census was conducted during the Covid-19 pandemic which may have skewed

some of the results, especially in relation to numbers from home, but would still indicate a shift towards greater home working, in line with national trends). In 2021 32.4% of the working population worked mainly from home (compared with 18.9% in 2011) 20.9% travelled between 10 and 20km (26% in 2011). A further 12.7% worked between 5 and 10km from home (20.8% in 2011). Other than those working from home, only 3.1% travelled less than 2km (6.1% in 2011): 2.7% worked more than 60km from home (3.5% in 2011). 16.9% worked at an offshore installation, in no fixed place, or outside the UK (no equivalent figure for 2011). The fall in local working reinforces the lack of locally-employed people on the industrial estate.

Among households, 5.5% had no cars or vans, 28.7% had one car, 43.1% had 2 cars and 22.7% had 3 or more cars or vans.

THE LOCAL PLAN CONTEXT

EAST DORSET AND CHRISTCHURCH LOCAL PLAN PART 1 - CORE STRATEGY, ADOPTED APRIL 2014

3.4.2 The Neighbourhood Plan has been written to be in general conformity with the East Dorset and Christchurch Local Plan Part 1 (the Core Strategy)². This was the adopted Local Plan at the time this Neighbourhood Plan was written and covers the period to 2028 (although it will be replaced before then).

3.4.3 A list of the most relevant policies for our Neighbourhood Plan area is included in **Appendix 1**. Of particular importance are the policies setting out the settlement strategy and amount of development envisaged. Policy KS2 is the main policy covering this, supported by policies LN4, LN7, PC1, PC4, PC5 and RA1. Together, these identify the village of Sturminster Marshall as a Rural Service Centre with the ability to identify rural exception sites (under Policy LN4), new services and facilities (under Policies PC5 and LN7) and potentially some economic development (under Policies PC1 and PC4). The only strategic allocation (which required the release of Green Belt land) was in relation to an extension of the Bailie Gate Industrial Estate, to help meet the future needs of businesses throughout East Dorset, but particularly the rural areas of East and North Dorset. The village envelope had been defined through policy SM1 of the previous 2002 Local Plan, which excluded those areas of the village from the Green Belt where windfall or infill development would potentially be permitted. In doing so, it acknowledged that there were no specific needs for additional housing in the village at that time, having gone through a period of substantial expansion in the late 20th century, and there was no clear requirement for additional housing to support the community facilities that did exist.

3.4.4 There are also policies covering environmental protection, such as those dealing with biodiversity, flood risk, heritage and landscape quality, as well as guidance on general matters such as design, layout, open space provision, sustainability development standards etc.

EAST DORSET LOCAL PLAN OPTIONS (CONSULTATION DRAFT), PUBLISHED JULY 2018

3.4.5 East Dorset Council began preparing a new Local Plan and published the first draft in July 2018³. This draft identified Sturminster Marshall as a relatively large rural village offering a small range of services and facilities. In contrast to the previous strategy, it proposed options for modest housing growth in the village, approximately 250 units, on land off Station Road and at Springfield Farm where Green Belt impact would be lowest.

² <https://www.dorsetcouncil.gov.uk/planning-buildings-land/planning-policy/christchurch/local-development-framework/local-plan-part-1/christchurch-and-east-dorset-local-plan-part-1-core-strategy>

³ <https://www.dorsetcouncil.gov.uk/planning-buildings-land/planning-policy/dorset-council-local-plan/reviews-of-the-plans-from-the-former-council-areas/east-dorset-and-christchurch-local-plan-review>

3.4.6 Following the merger of the Dorset councils in 2019, Dorset Council made the decision to halt work on the separate Local Plans (with the exception of Purbeck) and instead press ahead with a new Dorset wide Local Plan.

DORSET COUNCIL LOCAL PLAN (OPTIONS CONSULTATION DRAFT), PUBLISHED JANUARY 2021

3.4.7 The consultation for the first draft of the Local Plan for the Dorset Council area ran between January and March 2021. The draft plan identified potential development options as:

- Land at Station Road, to the south-east of the village (estimated at 225 new homes);
- Land at Springfield Farm, to the north-west of the village (estimated at 60 new homes);
- Sturminster Marshall Golf Course, to the east of Sturminster Marshall (estimated at 140 new homes);
- The extension to the Bailie Gate Industrial Estate (as previously allocated) as well as further opportunities within the existing industrial estate.

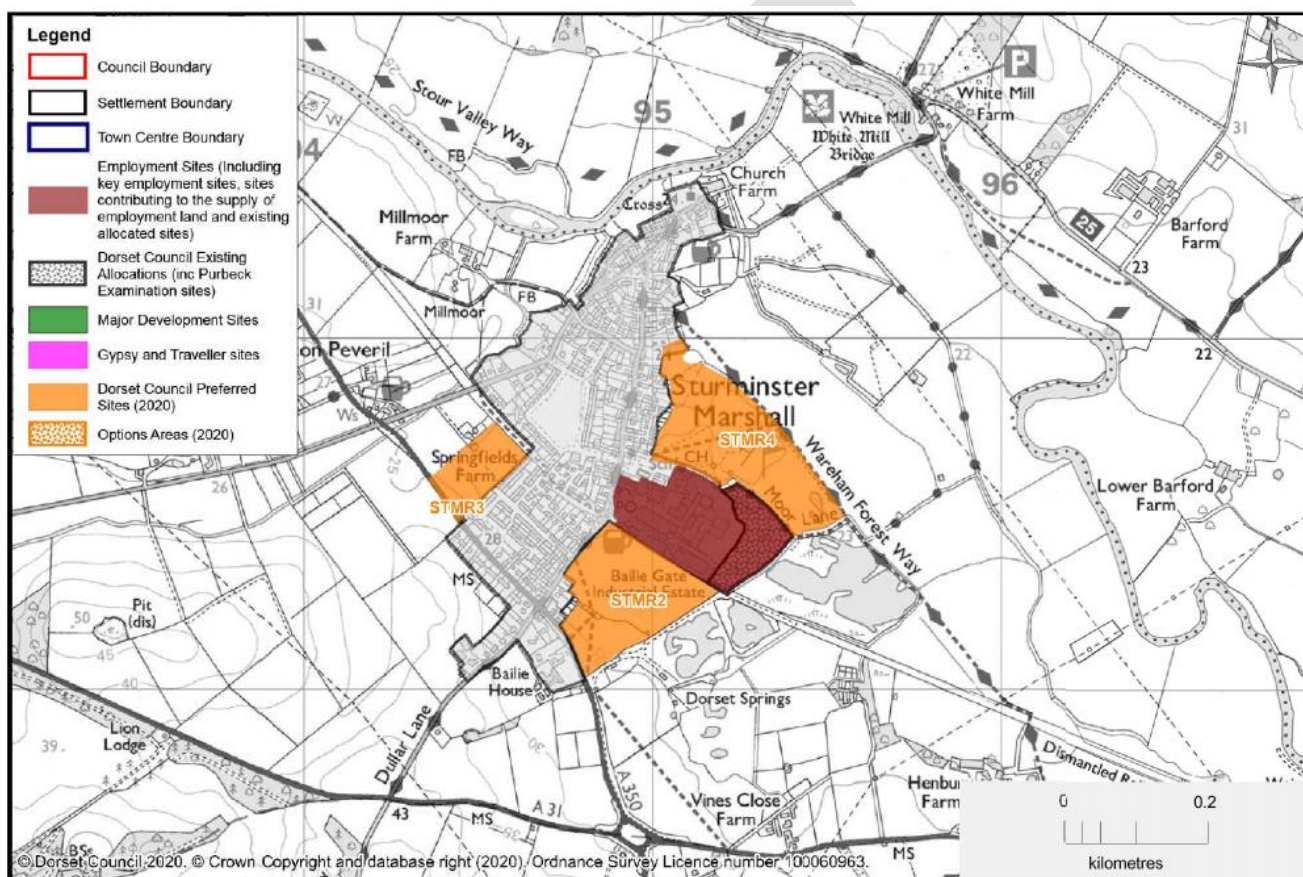

Map 2. Proposed development sites, Dorset Council Local Plan Options Draft, January 2021

3.4.8 Whilst it was initially anticipated that the new Local Plan would be adopted by April 2024, the latest timescale, set out in the October 2022 Local Development Scheme, now suggests that the next draft of the Local Plan will not be published before Autumn 2024, with adoption possibly by Spring 2026. It is also relevant to note that the Government has indicated as part of its latest consultation (December 2022)⁴ that the standard method is due to be reviewed in 2024 after the new household projections data based on the 2021 Census are published, and that demographic and geographic factors (such as Green Belt) may be used to vary this. As such there is some degree of uncertainty as to what the final housing target figure may be, and the extent to which any Green Belt sites may be released.

⁴ <https://www.gov.uk/government/consultations/levelling-up-and-regeneration-bill-reforms-to-national-planning-policy>

4. ABOUT THIS NEIGHBOURHOOD PLAN

4.1 WHAT IS NEIGHBOURHOOD PLANNING?

4.1.1 The Localism Act, which came into force in April 2012, gives communities power to develop a shared vision for their neighbourhood and shape the development and growth of their local area. Neighbourhood planning provides a powerful set of tools for local people to influence types of development required to meet their community's needs.

4.1.2 Decisions on planning applications will be made using both the Local Plan and the Neighbourhood Plan. Because of this, Neighbourhood Plans are covered by detailed central government guidance and legislation. A Neighbourhood Plan must be broadly in line with National Planning Policy and the strategic policies for the area that are contained in the Local Plan prepared by the Local Planning Authority, in our case, Dorset Council. Once adopted, it forms part of, and sits alongside, the Local Plan.

SOME BASIC RULES

All neighbourhood plans must meet 'the basic conditions' set out in planning legislation. These relate to having regard to national policy, achieving sustainable development, and general conformity with strategic local policy. The plan must also comply with human rights law.

4.2 WHAT IS IN IT?

4.2.1 This Neighbourhood Plan focuses on matters specific to Sturminster Marshall Parish which were identified through research, surveys and public consultation. The Plan includes:

- A brief overview of the history and character of the parish of Sturminster Marshall
- A description of the current issues facing the Parish, including the proposals for development set out in the current adopted Local Plan, and the community's concerns and aspirations relating to Climate Change, Heritage, Environment, Housing, Community Facilities and Traffic & Transport.
- A vision for the parish, and objectives which will guide the policies in the Plan, together with projects and actions that should help to achieve the goals and deliver the policies.

4.2.2 A list of all the documents compiled as part of the evidence base supporting this plan is contained in **Appendix 2**.

KEY ASPECTS OF THE PLAN

4.2.3 A strong message that came through all the consultations was how much local people valued their environment. This has very much shaped this Plan, and we have included policies to protect the landscape, wildlife and historic features, as well as designating important green spaces in and around the village.

4.2.4 The main need for development in our area is for housing particularly, genuinely affordable housing. We accept that an appropriate level of development is needed in order to ensure that we keep and enhance our businesses and services (including village shops local pubs), and community facilities such as our school, Memorial Hall and recreational areas. We will look to negotiate funding from developer contributions to improve these. Dorset Council's Draft Local Plan proposes that Sturminster Marshall acts as a "Rural Centre" without detailing what is envisaged.

4.2.5 We have found no evidence of any significant need to identify more employment land, as land has already been allocated to expand Bailie Gate Industrial Estate.

4.2.6 Significant areas of the Parish are prone to flooding. We ask developers to use the latest information to ensure development does not take place in areas at risk of flooding currently or in the near future, or worsen the possibility of flooding off-site."

4.2.7 Traffic (speed and parking) is a real concern for local residents. So we want to make sure that people are able to walk and cycle safely around our village and out to the surrounding countryside through improving the area's interconnectivity. There is also a need to raise awareness of the need to properly assess the impacts of traffic along the A350 and access to the village along Station Road.

4.2.8 Design guidance in the plan reflects the distinctive character of different parts of our parish, lessons learnt from recent developments, and the changes that may be needed to reduce the impact of climate change, including support for zero-carbon homes.

4.3 HOW WAS IT PREPARED?

4.3.1 In September 2018, Sturminster Marshall Parish Council resolved to prepare a Neighbourhood Plan – an open meeting was held and members of the public were invited to join a Neighbourhood Plan Steering Group. By April 2019, Dorset Council had accepted our application to designate the entire parish as the Neighbourhood Plan Area.

4.3.2 The Steering Group researched existing plans and survey material, carried out new surveys, held public consultation events, and liaised with households, landowners, local businesses and community groups. It also engaged consultants to prepare reports on particular issues, such as a Housing Needs Assessment, Site Assessments, Strategic Environmental Assessments and Design Guidance. The Group met together regularly with Sturminster Marshall Parish Council representatives to report and discuss their findings. Guidance was also sought from Dorset Council. Details of the consultations and research reports are available on the Parish Council's website.

4.3.3 The intention had been to use the Neighbourhood Plan to guide development on sites that were being proposed through the Dorset Council Local Plan, who had suggested releasing Green Belt land. However with the Local Plan being delayed, we could either put our work on hold for perhaps two years, or progress the Plan with a reduced scope, without identifying how much and where future development should happen. We chose the latter. Once the level of housing and employment in our parish has been decided through the Local Plan (which would require the release of land from the Green Belt), our Neighbourhood Plan will be updated to incorporate detailed policies on the proposed sites.

NEIGHBOURHOOD PLAN – KEY STAGES

- Designate Neighbourhood Plan area
- Research and draft the Plan
- Consult on the draft Plan (Pre-Submission)
- Consider responses and make changes, then submit the Plan for examination
- Consult on the draft Plan (Regulation 16)
- Appoint the Examiner
- Consider the Examiner's report and make further changes as recommended
- Hold Referendum on whether the final plan should be used.

4.4 WHAT STAGE HAS THE PLAN REACHED?

4.4.1 This is the first complete draft of the Sturminster Marshall Neighbourhood Plan – known as the “pre-submission draft”. Regulation 14 of the Neighbourhood Plan legislation requires that the plan must be consulted on for at least six weeks. The Parish Council will arrange the six-week consultation. Following this, all the responses will be considered, and changes may be made before the Plan is submitted to Dorset Council, who are responsible for organising the Plan's examination and referendum.

4.4.2 The Examiner's role is limited to testing whether the draft Plan meets the basic conditions, and other matters set out in legislation. The Examiner is not testing the soundness of the Neighbourhood Plan or examining other material considerations. Provided the Plan meets these basic conditions (and the Examiner may suggest modifications to ensure that it does) it will be submitted to a local referendum. If accepted by the community, it will become part of the Development Plan and will be used by the Dorset Council in making planning decisions.

4.5 HOW LONG WILL THE PLAN LAST?

4.5.1 This Plan looks ahead to 2033.

4.5.2 However it is likely that the Plan will be reviewed well in advance of this date, not only because the Local Plan will be updated in the next 5 years, but because there will also be changes in national planning policies and other material considerations that need to be taken into account in planning decisions.

DRAFT

5. VISION AND OBJECTIVES

5.1 BACKGROUND

5.1.1 National Planning Policy⁵ states that, “the purpose of the planning system is to contribute to the achievement of sustainable development.” It identifies three overarching objectives:

- **an economic objective** to be achieved by, “ensuring that sufficient land of the right type is made available in the right places at the right time to support growth, innovation and improved productivity; and by identifying and coordinating the provision of infrastructure;”
- **a social objective** “to support strong, vibrant and healthy communities, by ensuring that a sufficient number and range of homes can be provided to meet the needs of the present and future generations; and by fostering well-designed, beautiful and safe places with accessible services and open spaces that reflect current and future needs and support communities’ health, social and cultural well-being; and
- **an environmental objective** “to protect and enhance our natural, built and historic environment; including making effective use of land, improving biodiversity, using natural resources prudently, minimising waste and pollution, and mitigating and adapting to climate change, including moving to a low carbon economy.”

5.1.2 The Sturminster Marshall Neighbourhood Plan uses these principles as a starting point and seeks to apply them in a local context, using the results of consultation within the parish to develop a set of policies which provide a framework for development over the period of the plan.

5.2 VISION

5.2.1 The vision and objectives are based on the key issues raised by local people during the initial stages of the consultation process. They have been summarised and refined by the Steering Group to form the basis of the Neighbourhood Plan.

5.2.2 An initial questionnaire asked residents what they valued most in the parish and for their vision of how they would like to see it in 2033. The largest response was that the rural character should be retained and that there should be better amenities and facilities. Any new developments would be of an appropriate scale and provide a mix of housing types appropriate to local needs (especially the provision of a higher proportion of affordable homes) along with necessary improvements to local infrastructure. Development would be sensitively located and designed to ensure that the cherished natural environment and rural character of the parish is maintained.

5.2.3 Based on views expressed in the series of consultations and responses to questionnaires, the vision of the Neighbourhood Plan is five-fold, namely:

- To help support a strong, vibrant and healthy community for all who live or work in the parish.
- To maintain the essential character of the parish and its different component settlements through sensitive development of a well-designed and safe built environment, and its associated infrastructure.
- To address our long-standing issues of flooding, traffic and affordable housing.

⁵ Section 2 of the National Planning Policy Framework, 2021, <https://www.gov.uk/guidance/national-planning-policy-framework/2-achieving-sustainable-development>

- To contribute to protecting and enhancing our natural, built and historic environment, including making effective use of land and helping to use natural resources prudently.
- To help maintain or improve biodiversity by minimising waste and pollution, and by adapting to climate change and mitigating its effects.

5.3 OBJECTIVES

5.3.1 The vision allowed us to identify a number of objectives which, in turn, shaped the development of the Plan and its policies under six main headings: Climate Change, Natural Environment (landscapes, habitats and wildlife), Built Environment (heritage), Homes and Businesses, Community Facilities, Traffic & Transport.

CLIMATE CHANGE AND FLOOD RISK

- Achieve the highest energy efficiency standards in all new development.
- Minimise the production of waste in construction.
- Embed efficient water management in all developments.
- Encourage the use of renewable energy technologies wherever these would be appropriate.
- Include climate change mitigating measures against foreseeable effects.
- Ensure that any new development does not increase flooding or pollution risks within the parish or further downstream in the Stour Valley.

NATURAL ENVIRONMENT – LANDSCAPES, HABITATS AND WILDLIFE

- Ensure that development is sensitive to the rural setting of the parish and does not adversely impact its character, environment or landscape.
- Protect green spaces and recreational trails valued by local residents and create new ones wherever possible.
- Promote the protection of semi-natural habitats within the parish and, where possible, encourage enhancement of biodiversity.

BUILT ENVIRONMENT – HERITAGE AND DESIGN

- Achieve a better understanding of the historically important buildings and other heritage assets and how they contribute to local character. Identify the characteristic

buildings and features in the distinct areas of the parish that should be retained in future developments.

- Ensure that the character of the area (including the outlying settlements) and the setting of these assets is not compromised by the presence of new developments, through the careful consideration of location, layout, scale, design and materials used.

HOMES AND BUSINESSES

- Provide opportunities for local people to continue to live in the area by encouraging an appropriate mix of housing types within any new development. This should include sufficient numbers of affordable homes for first-time buyers and young families, and housing suitable for older, retired people.
- Encourage employers to provide employment opportunities within the parish for local people.

COMMUNITY FACILITIES

- Protect and enhance the range of community facilities in the Parish including retail, sport, play, education, and social infrastructure.

TRAFFIC AND TRANSPORT, WALKING AND CYCLING

- Reduce problems associated with street parking, especially close to the school and retail outlets.
- Explore ways in which traffic movements may be modified to avoid congestion, in particular, along Station Road and sections of High Street.
- Identify where opportunities may arise to create safe routes for walkers, cyclists and horse riders.

6. CLIMATE CHANGE AND FLOOD RISK

OBJECTIVES

- Achieve the highest energy efficiency standards in all new development.
- Minimise the production of waste in construction.
- Embed efficient water management in all developments.
- Encourage the use of renewable energy technologies wherever these would be appropriate.
- Ensure that any new development does not increase flood or pollution risks within the parish or further downstream in the Stour Valley.
- Include climate change mitigating measures against foreseeable effects.

6.1 INTRODUCTION

6.1.1 One of the biggest challenges of our age is climate change, which is already happening and has begun to cause irreversible damage to parts of our environment⁶. Further consequences and risks will depend on our capacity to limit the pace and extent of global warming. Even a small shift in average climate conditions can produce severe effects, such that what may have once been a 1 in 100 year flood, or excessive heat wave, may become a more common event.

“We are already seeing increased numbers of heavy rainfall events and expect this increase to continue, with greater risk of river and flash flooding.”

6.1.2 Of those responding to our initial household survey, 78% thought that climate change is an issue of serious concern and should be addressed in the Neighbourhood Plan draft policies. Because flooding is a constant threat within the parish, they were also concerned that development should not increase flood risk or pollute our streams and river network.

6.1.3 Climate change impacts not only impact people, but also wildlife and how our infrastructure and natural environment systems work. Extreme events resulting in aridity or waterlogging can present risks to terrestrial and freshwater species and habitats, to soils and carbon stores, to agriculture and forestry, to infrastructure and services such as water supply and transport, and erode or damage our cultural heritage. Indirect effects include increases in the number or distribution of pests, pathogens and invasive species.

6.1.4 Countering many of these effects is beyond the scope of just the Neighbourhood Plan. The UK Government has set a legally binding target to achieve net zero greenhouse gas emissions from across the UK economy by 2050⁷, and in 2020 Dorset Council produced its Climate and Ecological Emergency Strategy and Action Plan. Sturminster Marshall Parish Council is drafting its own action plan, which should be finalised in 2023.

Figure 1. Flooding in Mill Lane from river overtopping



⁶ Climate Change Explained – Government Guidance, 2019 <https://www.gov.uk/guidance/climate-change-explained>

⁷ Climate Change Act 2008 as amended, <https://www.legislation.gov.uk/ukpga/2008/27/contents>

6.2 SUSTAINABLE DEVELOPMENT STANDARDS

6.2.1 The nature of development itself can help mitigate the drivers of climate change by adhering to the highest standards of energy efficiency, and reduction of waste and pollution, both in design and in construction methods and practice. Dorset Council now require a statement to demonstrate how sustainable design and construction have been addressed, including reducing energy consumption and carbon emissions, minimising waste and increasing recycling, conserving water resources, incorporating green infrastructure and sustainable drainage, minimising pollution, maximising the use of sustainable materials and adaptation to Climate Change⁸.

6.2.2 Having reviewed the existing policies (ME1 and ME4) in the adopted Local Plan, these are very thorough and do not need to be reproduced. The baseline for standards is set nationally through Building Regulations, but developments can achieve higher standards, and developers are expected to consider how this can be achieved, unless there are practical or viability reasons why higher standards are not possible. The following policies therefore seek to build on these requirements.

6.2.3 Additional guidance on the following specific matters relating to design is covered in the policies cross-referenced from the following policy.

Policy SMNP1. SUSTAINABLE DEVELOPMENT STANDARDS

Proposals for new buildings must demonstrate they have integrated or considered the following within their design process:

- **Energy efficiency** - using technology, design elements and the site's characteristics to create thermally efficient buildings, and installing low -carbon decentralised energy infrastructure appropriate to the site and surroundings;
- **Conservation of water resources** - through water efficient infrastructure, harvesting of rainwater and use of greywater;
- **Flexible and adaptable buildings** - using designs and construction methods that will enable future alterations;
- **Sustainable materials** – through the use of materials that are recycled or locally sourced, have low embodied energy and have been produced with minimum ecological damage;
- **Climate change adaption** - ensuring landscapes, materials, façade treatments and infrastructure are appropriate to anticipated climate change.

6.3 FLOOD RISK

6.3.1 The threat of flooding has been, and will continue to be, an important factor in determining patterns of development in Sturminster Marshall village and the settlements along the Winterborne valley. There are three reasons for flooding in our area:

- When the River Stour bursts its banks after major precipitation events in the catchment area – this can cause extensive flooding, particularly over adjacent fields.

According to the National Trust, the mill on the far side of White Mill Bridge has been swept away by floods at least twice in its history (about 1480 and in 1775)

⁸ Dorset Council Planning Applications – National and Local List of Requirements, October 2022
<https://www.dorsetcouncil.gov.uk/documents/35024/286094/New+Validation+Checklist-+V5+-+Final+updated-08-02-2023.pdf/eea078a2-a51e-7d10-013f-31541f9a99aa>

- When groundwater levels rise in the underlying gravels – triggering springs and areas of groundwater flooding both within and outside the established flood risk zones.
- When there are heavy or prolonged periods of rain, creating surface water run-off – this tends to collect in a number of low-lying spots, leading to localised flooding.

In addition, there have been instances of rainwater inundating the sewage systems and overflowing, although recent improvements appear to have largely resolved this issue.

Figure 2. (right) Flooding from a rise in water table at Stocks Green

Figure 3. (below) Surface water run-off flooding collecting opposite the school



6.3.2 The northern end of Sturminster Marshall village (in particular the area between Newton Road and Church Farm, and near the meeting of High Street and Church Street) benefits from flood defences, built in 1994, that counter a 1 in 100 year flood event, and need to be maintained.

6.3.3 Springs are found in various parts of the parish, for example SE of Sturminster Marshall village, in and around Dorset Springs, which was formerly watercress beds. Other springs along the Winterborne Valley below Westley Wood combined with high levels in the River Winterborne (which is a winterbourne river flowing only when groundwater levels are high) can lead to extensive flooding affecting the road and adjacent fields between Newton Peveril and Stag Gate. Higher up the Winterborne valley, between the Stag Gate and Almer, flooding, mainly of fields, occurs regularly in winter. The temporary pond in Bartons Ground and flooding in the fields adjacent to the north-eastern side of the golf course are also a product of winter raising of ground water levels.

6.3.4 Surface water flooding most frequently occurs in areas such as the junction of Front Lane and Church Street, parts of High Street and Newton Road, Moor Lane and the lower end of Station Road in Sturminster Marshall village. It also happens where roads, running downhill in two directions from the ridge above Mapperton meet, although the problem has been alleviated to some extent by construction of a run-off pond taking excess water on to an adjacent field. Raised groundwater also causes problems in this area where properties have been flooded: privately upgraded drainage systems are addressing this problem. Beyond the built-up parts of the parish, fields either side of the road from Church Farm to White Mill Bridge are frequently flooded in winter by a combination of rising groundwater levels and overtopping of the River Stour, which can, at times, force closure of this road.

6.3.5 Dorset Council are updating the Strategic Flood Risk Assessment (SFRA) and we still awaiting this report. This will be used to consider the strategic approach to where development takes place across the county. As part of this work, additional research has been undertaken in respect of groundwater flooding, and initial data on groundwater emergence have been mapped.

- 6.3.6** The following map (sourced from Dorset Explorer⁹) shows those areas currently identified as either:
- Flood Risk Zone 3 (where there 1% or higher probability of river flooding happening in any given year)
 - 1% surface water flood risk (where there is a 1% chance of flooding happening in any given year)
 - Groundwater emergence flood risk (where groundwater levels are typically less than 0.5m below the surface)

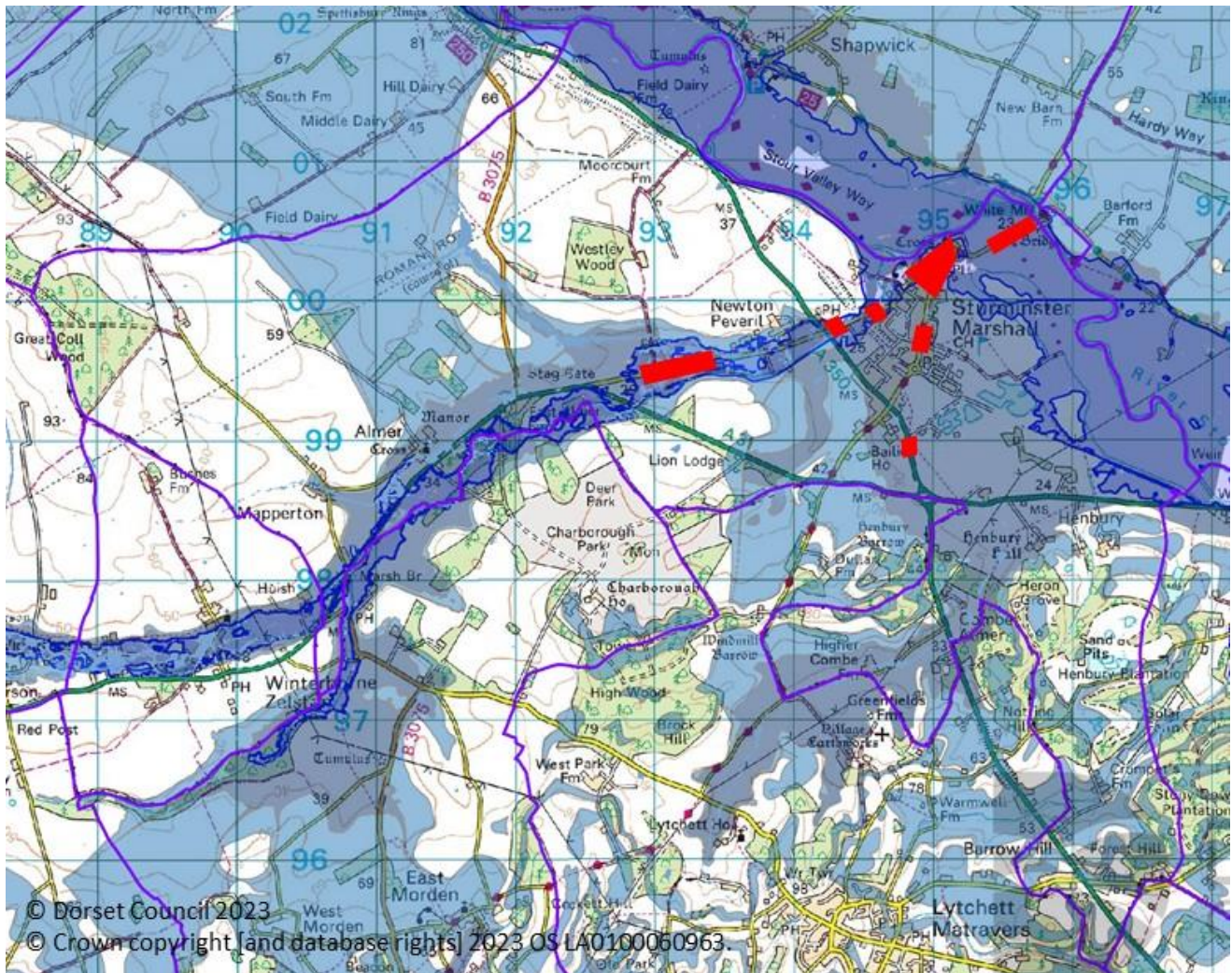

Map 3. Flood risk areas in Sturminster Marshall parish where a Flood Risk Assessment is likely to be required.

6.3.7 Whilst these data sources do not show risk of flooding per se, they give an indication of the significant scope for flooding in the area. National planning policy is clear that areas at risk from flooding should not be developed (particularly in relation to development where people could be placed at risk) if there are less vulnerable flood risk areas available. Where there is no suitable alternative sites, then measures should be put in place to show that the flood risk can be mitigated to an acceptable (safe) level, both on and off-site.

6.3.8 As part of any assessment, access during an emergency will also need to be considered. The map indicates (in red) those roads which have been known to become impassable as a result of flooding in recent years.

FLOOD-RELATED POLLUTION

6.3.9 In 2019, the Environment Agency classified parts of the River Stour, including the section within Sturminster Marshall, as being of “Poor Ecological Status” according to the EU Water Framework Directive.

⁹ <https://gi.dorsetcouncil.gov.uk/explorer/>

This is understood to be largely as a result of diffuse sources from agricultural and rural land management, but also in part due to sewage discharge¹⁰. Wessex Water have identified risks from peaks in high nitrate levels in Sturminster Marshall and Shapwick and has said that it is working with local farmers to reduce nitrate losses from agricultural land into the aquifer. They are also funding the River Stour Phosphate Reduction Scheme in an attempt to reduce inputs of phosphates. It is hoped that such initiatives will help improve water quality in the two rivers in the area.

6.3.10 The infiltration of groundwater into the sewer network has contributed to sewerage-related pollution of the river network. Wessex Water have investigated sources of infiltration into the sewage system and sealed pipes in order to reduce the risk of groundwater entering. In their Sturminster Marshall and Shapwick Infiltration Reduction Plan summary for April 2021 to March 2022¹¹, they report that there is still evidence of some infiltration, although only three incidents (due to inadequate hydraulic capacity) have been reported since 2016. In their response to Dorset Council's Draft Local Plan, Wessex Water identified that significant improvements to the sewerage system are likely to be required to serve the cumulative level of development for this area¹².

SUSTAINABLE URBAN DRAINAGE SYSTEMS (SUDS)

6.3.11 SuDS cover a range of approaches to managing water in a more sustainable way to reduce flood risk and improve water quality whilst improving amenity benefits. It works by reducing the amount and rate at which flood water reaches a waterway or combined sewer system. This considers how water can be collected and stored (for example in a water butt or rainwater harvesting system), whether it can be re-used, and how it can be released back into the catchment, either through **infiltration**, where water percolates into the ground – potentially via soakaways and use of permeable surfaces; and **attenuation and controlled release**, where water is held back, and slowly released it into the drainage network – potentially in swales or similar receptacles.

6.3.12 What measures are practical will depend on the site-specific conditions such as underlying soil types, groundwater levels, infiltration rates, topography and space. Some of the most effective SuDS are vegetated, using natural processes to slow and clean the water whilst increasing the biodiversity and landscape value of the area. Given the rural nature of the area, a vegetation-based SuDS is to be preferred. The future management and maintenance of such systems should be clearly set out.

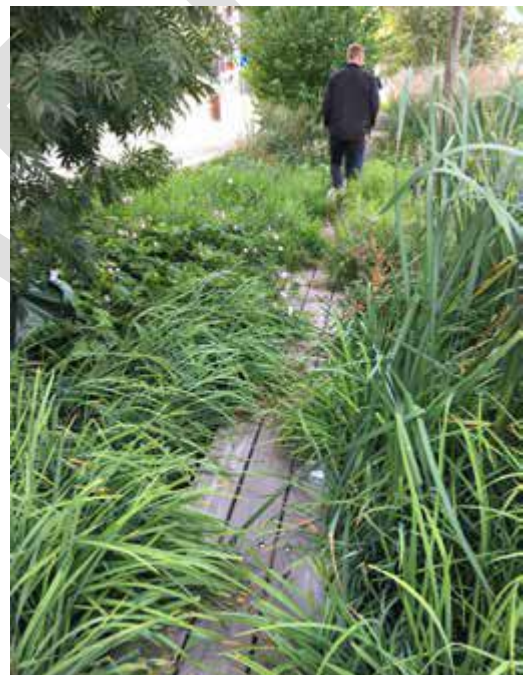

Figure 4. Example of SuDS designed as a public amenity and fully integrated into the design of the public realm

¹⁰ Dorset Council Local Plan Sustainability Appraisal Scoping Report, 2019
<https://www.dorsetcouncil.gov.uk/documents/35024/282495/SA+scoping+report+draft+AFTER+CONSULTATION+2+Redacted.pdf/5b36438e-f47e-54a6-4e02-7aeb66162434>

¹¹ <https://www.wessexwater.co.uk/environment/drainage-and-wastewater-management-plan/infiltration-reduction-plans>

¹² Wessex Water response to Dorset Council's Draft Local Plan consultation, Spring 2021
<https://www.dorsetcouncil.gov.uk/documents/35024/3473863/Final+Consultation+Summary+-+Sturminster+Marshall.pdf/cfcd835b-66af-d0f6-d7df-b0b935a3ae9b>

Policy SMNP2. CONTROL OF FLOODING

All developments must be undertaken in such a way that they do not increase flooding risk within the parish or beyond its limits. To achieve this, the following measures need to be taken:

- A site specific and proportionate Flood Risk Assessment (FRA) is to be submitted in support of all development proposals in the areas identified at risk of flooding as shown in Map 3. This should include an assessment of site characteristics / ground conditions, identify any prevailing flood risk from all potential sources (i.e., fluvial, surface and ground water / springs, and sewers), and outline the mitigation measures that are to be adopted.
- The specific use of infiltration measures and soakaways is to be substantiated by appropriate investigation and testing according to the ground conditions and potential groundwater levels.
- There will be presumption against proposed developments with a significant risk of increased runoff, unless accompanied by a demonstrably efficient SUDS system.

Any development will need to demonstrate that it would not compromise water quality in groundwater or the river system.

Where practical, SuDS should be vegetated and use natural processes to slow and clean the water whilst increasing the biodiversity and landscape value of the area.

Policy SMNP3. SEWAGE TREATMENT WORKS

Major development will be required to demonstrate that any necessary upgrades to the sewage treatment works (as advised by Wessex Water) will be in place prior to the site's occupation.

7. NATURAL ENVIRONMENT– LANDSCAPES, HABITATS AND WILDLIFE

OBJECTIVES

- Ensure that development is sensitive to the rural setting of the parish and does not adversely impact its character, environment or landscape.
- Protect green spaces and recreational trails valued by local residents, and create new ones wherever possible.
- Promote the protection of semi-natural habitats within the parish and, where possible, encourage enhancement of biodiversity.



7.1 INTRODUCTION

7.1.1 In our public consultations we found that many residents placed great value on local landscape character, including views, and on the natural and historic environments.

7.1.2 Most of the parish lies within the Dorset Downs and Cranborne Chase National Character Area (NCA) whilst the Jubilee Cross part is within the Dorset Heaths NCA. The Cranborne Chase and West Wiltshire Downs Area of Outstanding Natural Beauty (AONB) lies to the north, with the parish part of its wider setting. The flat, meandering Stour Valley, together with part of the South Blandford Downs, is also designated locally as an Area of Great Landscape Value (AGLV)¹³. About half of the plan area lies within the South East Dorset Green Belt, which surrounds the Poole / Bournemouth conurbation. National planning policy requires that these valued landscapes are protected and enhanced, and substantial weight is given to any harm to the Green Belt¹⁴.

¹³ A description of the features warranting this designation is given in a 1997 East Dorset District Council publication East Dorset District Council Areas of Great Landscape Value, Supplementary Planning Guidance, June 1997 <https://www.dorsetcouncil.gov.uk/documents/35024/286287/AGLV%20Text.pdf/4657a510-ff73-ec6f-d51c-8c875963bf53>

¹⁴ Sections 13 and 15 of the National Planning Policy Framework, 2021, <https://www.gov.uk/guidance/national-planning-policy-framework/13-protecting-green-belt-land> and <https://www.gov.uk/guidance/national-planning-policy-framework/15-conserving-and-enhancing-the-natural-environment>

Map 4. Sturminster Marshall parish in relation to Green Belt and AONB, Green Belt and AGLV

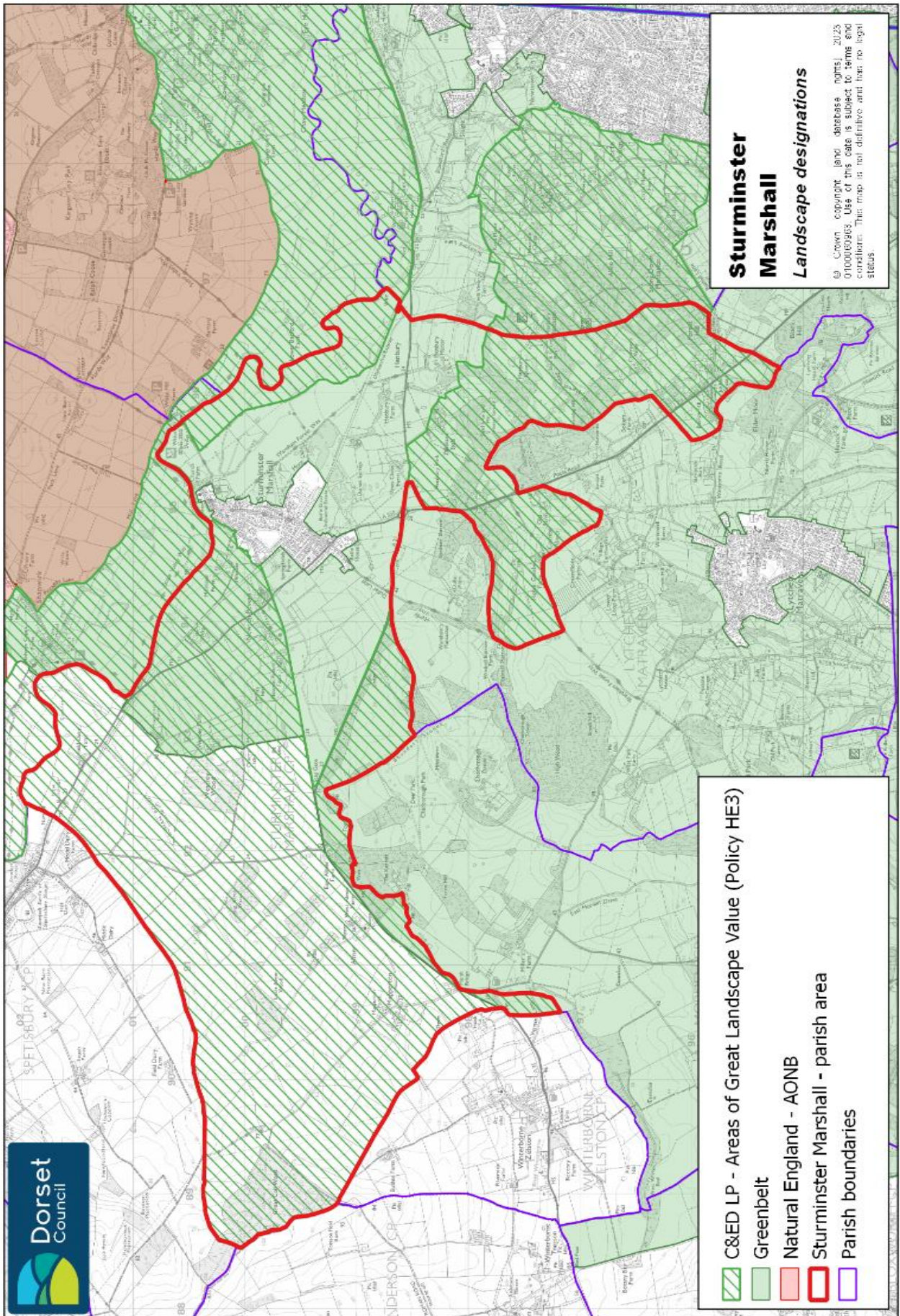

7.2 LANDSCAPE CHARACTER

7.2.1 Dorset Council's Landscape Character Assessment¹⁵ identifies different landscape character types within the parish. These are described in brief below and shown on Map 5:

OPEN CHALK DOWNLAND

A very small area at the western end of the parish is open chalk downland, and largely comprises Great Coll Wood – a plantation of conifer and broadleaved trees – one of the “isolated small blocks of geometrically shaped woodland”.

CHALK VALLEY & DOWNLAND (INCLUDING CHALK RIVER VALLEY FLOOR)

Much of the north-western part of the parish comprises gently undulating downlands sloping down towards the Stour and Winterborne.

The area is intensively farmed with large to medium-sized, geometric fields bordered by low, straight, clipped hedges. Copses and hedgerows along the length of the river valley floor contribute to a sense of containment in that location. The dry valley extending northwards from East Almer creates a more irregular landform.

RIVER TERRACE

The Sturminster Marshall River Terrace is an area of clay-enriched soils lying largely on valley gravel to the south of the Stour Valley. The mainly arable fields are large but of irregular shape and contained by low boundary hedges. Tree cover is sparse and generally confined largely to field boundaries.

The village lies within this area, with its riverside origins. More man-made landscapes - a golf course and a series of large fishing lakes - lie to the south east of the settlement, but do not dominate its rural character.

VALLEY PASTURE

Immediately adjacent to the River Stour is a flat alluvial plain which is characterised by large open fields of permanent grassland subject to periodic flooding.

ROLLING WOODED PASTURE

This area, in the southern part of the parish is divided into a patchwork of small, enclosed fields and paddocks connected by a network of lanes, with a more wooded landscape in the vicinity of Heron Grove. Sand and gravel extraction takes place in part of this area.

LOWLAND HEATHLAND

At the extreme southern end of the parish is a small patch of lowland heathland which is part of a more extensive area of heathland outside the parish to the south-east.

7.2.2 Tree Preservation Orders (TPOs) have been applied to two woodlands at Herons Grove and Forest Hill. Groups of trees in Bartons Ground and the track leading to it from High Street are also subject to TPOs. A small group of trees beside Newton Road in Sturminster Marshall village and a number of individual trees in the former parkland of Henbury Hall and Henbury House also have TPOs, together with a few other isolated trees within the parish.

7.2.3 In general, most residents felt that the level of street lighting in the existing areas is about right, with some in favour of more provision, and others seeking fewer street lights. About equal numbers responding to our survey supported no further street lighting, versus those supporting the use of street lighting (but using low energy / timed lights). On this basis, the key considerations are whether street lighting is necessary (taking into account safety considerations) and if so, how it can be designed to minimise flare and light pollution.

¹⁵ <https://www.dorsetcouncil.gov.uk/countryside-coast-parks/the-dorset-landscape/landscape-character-types>

Map 5. Landscape Character Areas

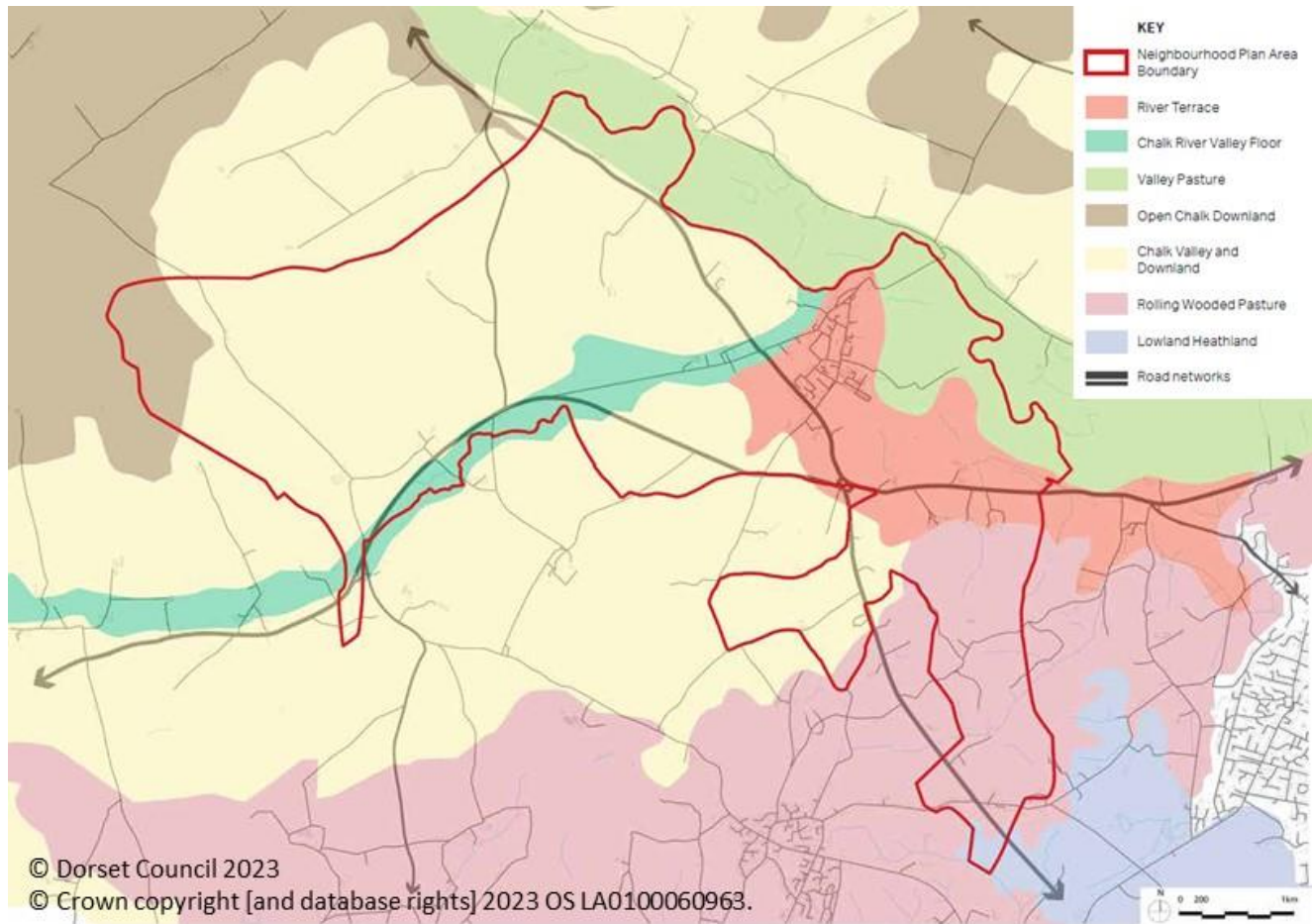

Policy SMNP4. MAINTAINING LOCAL CHARACTER

Development should retain the rural character of the area, paying particular regard to the retention, and where practical the enhancement, of landscape features that contribute to that area's character, including:

- Scale and nature of the field systems, and traditional field boundaries
- Extent and influence of tree and hedgerow coverage in that area
- Extent and influence of the river systems and the heath, chalk and woodland habitats
- Dark skies character of the countryside

7.3 VALUED WALKS AND VIEWS

7.3.1 The public rights of way network provides residents and visitors alike with opportunities to enjoy the intrinsic beauty of the countryside. Both the Hardy Way and the Wareham Forest Way pass through Sturminster Marshall village and link into The Stour Valley Way that is found on the far side of the River Stour. A further project – the Stour Valley Park – could add to this network of recreational routes and countryside access.

7.3.2 Panoramic views are limited, but can be enjoyed from the higher ground in parts of the parish. In our

STOUR VALLEY PARK

The Stour Valley Park is an emerging concept to improve recreational opportunities, wildlife and landscape that looks to link existing sites with new opportunities throughout the Stour Valley from Shapwick, through Sturminster Marshall and on to Christchurch Harbour.

The project is supported by a number of statutory and non-statutory bodies, including; Natural England, Wessex Water, the National Trust, the Environment



Figure 5: Pack Horse Bridge

2020 household survey local residents specifically mentioned the view from the top of Millmoor towards Badbury Rings. Bridleway E53/18, which forms part of the old drove to Blandford Forum, leads to this viewpoint from Kings Street and crosses the River Winterbourne via an ancient packhorse bridge. Extensive views across the Stour Valley can also be seen from bridleway E53/16 between the A350 and Westley Wood. Further West, this bridleway also offers views into Charborough Park, including the focal point of Charborough Tower and Stag Gate. Walks along the Straight Mile (the C23) heading west from Newton Peveril also focus on this Grade 2 historic landmark.



Figure 6: Local Landmark: Stag Gate

7.3.3 From Dullar Lane (the C117), where The Hardy Way enters the parish, Sturminster Marshall village is seen in its setting. The tower of St Mary's church is a prominent feature appearing above a line of trees. There are also more distant views towards the Iron Age Hill fort of Badbury Rings.

7.3.4 Many respondents to our consultations said they especially enjoyed views that included the river. Walnut Tree Field is a very popular recreation area and the only place within the parish where the banks of the River Stour can be accessed by the public. Other views of the river in a more rural setting can be obtained

from the Grade 1 listed structure of White Mill Bridge on the edge of the parish. White Mill Bridge was originally built around 1175 and is currently recognised as the oldest bridge in Dorset. The bridge today is a 16th century replacement built on timber pilings of the original. It is likely that the views of the bridge and its wider setting, which have remained largely unchanged, have been enjoyed for many centuries.

Figure 7: Local Landmark: White Mill Bridge

Figure 8: River Stour from White Mill Bridge



Map 6. Important recreational routes and landmarks (see also appendix 7)

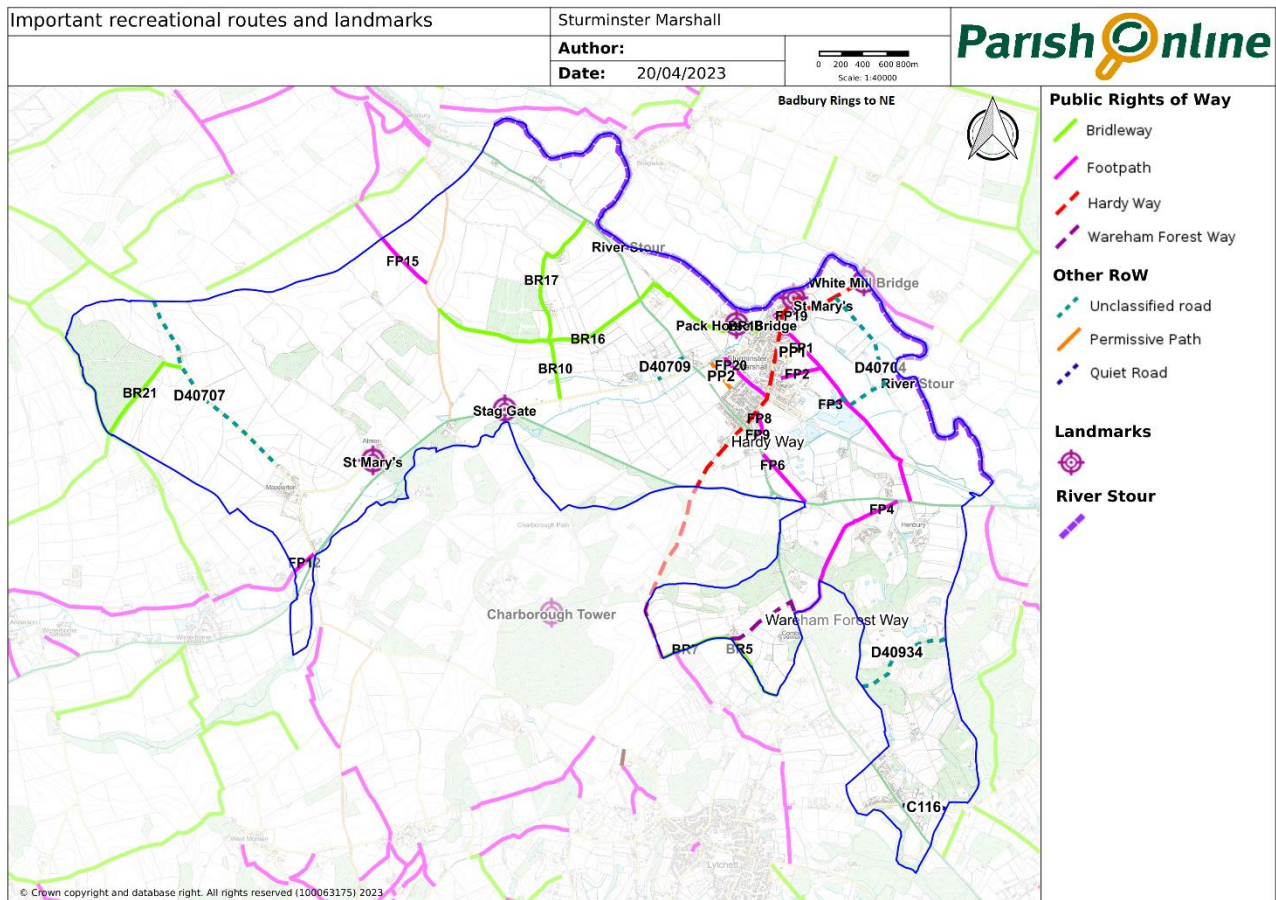

Policy SMNP5. VALUED VIEWS

Development should retain and where possible enhance access to the wider countryside. The scale, design and layout of development (including any landscaping) should minimise adverse impacts on publicly accessible views over open countryside, and towards key landmarks, including:

- The River Stour;
- White Mill Bridge;
- Packhorse Bridge at Millmoor;
- St Mary's church tower in Sturminster Marshall;
- St Mary's church tower in Almer;
- Stag Gate;
- Charborough Tower;
- Badbury Rings.

7.4 LOCAL GREEN SPACES

7.4.1 National planning policy allows communities to identify those places which are well related to existing settlements and hold a particular local value to be designated as “Local Green Spaces”. This designation provides strong protection against development, that should last well beyond the Neighbourhood Plan period.

7.4.2 Potential local green spaces were identified in our consultations and have been checked against the criteria set out in national policy. Those that met the criteria are described below, with more detail in **Appendix 3**:

BARTONS GROUND

An attractive open space on the edge of the village, with connections to a wider footpath network. It is also of wildlife value, being an area of permanent mesotrophic (neutral) grassland. The grounds are owned by Eton College and, until recently, was leased by the Parish Council allowing open access to the site. The lease has now been terminated by Eton College.

CHARBOROUGH GREEN

An informal recreation area owned by Dorset Council, providing an attractive space within the Railway Drive housing development.

CHURCHILL CLOSE

A large public open space owned by Sturminster Marshall Parish Council, within the heart of the village used for both informal and formal recreation. As well as the large open area, the approach from High Street is characterised by an avenue of lime trees set in wide verges with differential mowing to create a diverse habitat, especially for insects.

MAYPOLE GREEN, STOCKS GREEN AND TIMBER GREEN

A group of small registered village greens within the Sturminster Marshall Conservation Area. They are important meeting places (historically) and have a number of mature trees, with oaks commemorating; Queen Victoria’s jubilee, the coronation of Edward VII, the centenary of the Battle of Trafalgar, the coronation of George V, and the Armistice of 1918. A horse chestnut was also planted on Stocks Green to mark the coronation of George VI. There is a maypole (with seating at its base) topped by the village emblem of a water rat on Maypole Green, as well as a red



Figure 9: Lime trees in Churchill

telephone box, used as a book exchange, and a set of reproduction stocks on Stocks Green. Timber Green, as the name implies was formerly used for storing timber. Close by Stocks Green is Johnnies Ditch, running from Back Lane to the flood barrier. It is a location where drovers used to take stock to drink from the river: the site has been recognised as of special historical value within the conservation area by Sturminster Marshall Parish Council. Although it is now a raised area of permanent grassland, it was formerly a low point where the river came much closer to Back Lane than it does now (as shown on a tithe map from the mid-Nineteenth Century).

THE OLD RAILWAY LINE

This site has heritage value as part of defunct Somerset & Dorset Railway and is also used as a footpath connecting two parts of village. This section of the former railway line is owned by Dorset Council.

TRAFALGAR GREEN

Another small triangle of registered village green at the northern end of the Sturminster Marshall Conservation area. It is grassed with a bench and a commemorative oak tree (donated by the Duke of Wellington) marking the centenary of the Battle of Waterloo and provides an attractive, quiet, place to stop and rest.

WALNUT TREE FIELD

Site of medieval settlement. This field has much cultural significance as well as recreational value, being the only public open space with access to the river. It is also of wildlife value being an area of permanent mesotrophic (neutral) grassland. It is owned by Dorset Council.



Map 7. Local Green Spaces

Policy SMNP6. LOCAL GREEN SPACES

The local green spaces listed below, and identified on Map 7, are given special protection, and inappropriate development that would harm their reason for designation will not be permitted. Development within these areas must preserve their openness and not conflict with the purposes for which they were designated.

- Bartons Ground
- Charborough Green
- Churchill Close including approaches
- Market Place: Maypole Green, Stocks Green and Timber Green
- The Old Railway Line
- Trafalgar Green
- Walnut Tree Field

Development adjoining these areas must also respect their reason for designation and should not significantly detract from their enjoyment.

7.5 HABITATS AND WILDLIFE

7.5.1 At a time of increasing threat to many habitats, and the plant and animal species they support, it is important that we balance the needs for development with care of our natural environment. The Environment Act (2021) contains provisions for the protection and improvement of the environment, including introducing biodiversity net gain as a statutory requirement. This requirement is expected to come into force in 2023/24. As a result, there will be a clear mechanism by which habitats will be ‘valued’ and a plan (either on-site or through off-site measures) to achieve a minimum 10% increase in overall biodiversity. The Government’s consultation in early 2022, to shape the regulations that will detail how this will be applied, suggests that a simpler system may be introduced for small sites, and it is likely that householder applications and changes of use may be exempt from the requirements. Whilst there will be no need to repeat the legal requirements in local policy, a locally-specific policy can help set a more holistic approach and identify local strategies and issues that developers should take into account.

7.5.2 There are many locally important wildlife areas within the Sturminster Marshall Neighbourhood Plan area, largely centred on the rivers and small broadleaf woodlands in the parish. The river corridors, hedgerows, dismantled railway corridor, field margins and areas of woodland form an interconnecting network of wildlife corridors. Map 8 that follows identified those sites that have been designated or known to contain priority habitats, but additional sites (such as several ponds and the railway corridor) have been identified¹⁶.

Figure 10. Wildlife Corridors

PLANTING SCHEMES

To ensure resilience, a variety of tree and plant species is preferred. Species should be chosen to reflect the prevailing character of the landscape, soil conditions and the native species typical of the local area, but should also have regard to climate change, environmental / habitat benefits, size at maturity and ornamental qualities.



¹⁶ Dorset Explorer include layers for existing and higher potential ecological networks <https://gi.dorsetcouncil.gov.uk/explorer/?layers=18066,14746,14745,3965,544,51&basemap=26&x=393586.53&y=99641.40&epsg=27700&zoom=14>

Map 8. Locally designated sites and priority habitats

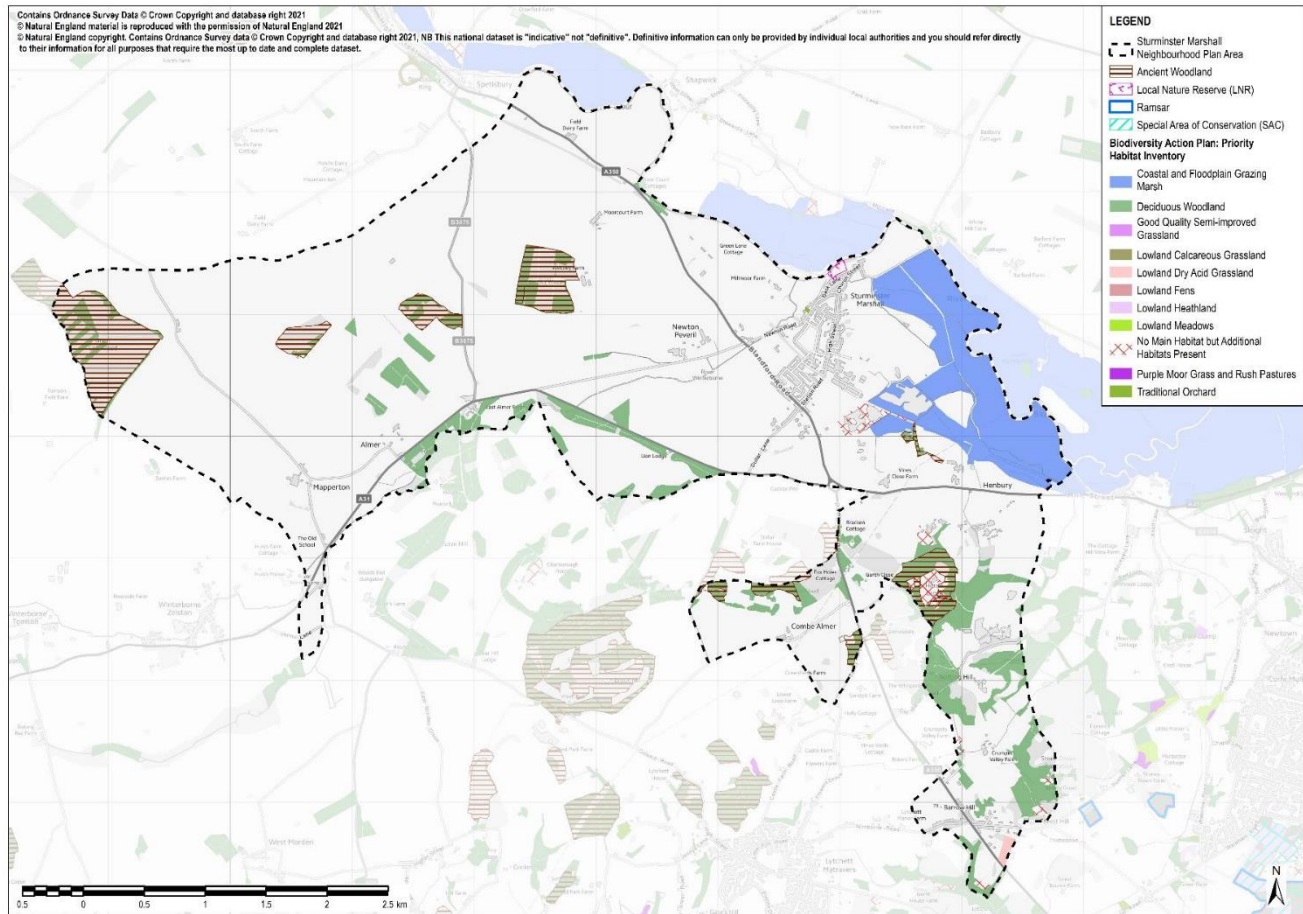

7.5.3 The abundance of trees is one of the Parish's greatest assets. Trees provide shading and cooling, absorb carbon dioxide, act as habitats and green links for species, reduce air pollution and assist water attenuation and humidity regulation. In contrast, there are comparatively few large woodlands, with most of the surviving fragments of woodland lie in two areas of the parish. One is on the higher ground on the southern side of the Stour valley, where a discontinuous arc of woodland stretches between Dullar Lane and Heron Grove and Forest Hill, towards the south-eastern part of the parish. The other is along the ridge in the north and western part, between Westley Wood behind Newton Peveril and Great Coll Wood above Mapperton where there are also smaller patches of woodland. All these areas have largely been replanted with conifers but do retain a fringe of broadleaf trees. A further, narrow strip of broadleaf woodland is also present along the southern side of the A31 in Charborough Park.

7.5.4 Adjacent to the Stour, in the eastern part of the parish winter flooding is common and here permanent grassland predominates. Areas of permanent mesotrophic (neutral) grassland can be found, such as in Walnut Tree Field and Bartons Ground, but are uncommon in the parish. Much of the farmland is improved grassland or cultivated for crops, and with enclosure awards only being made in 1845, some hedgerows are species-poor compared with hedges found in older man-made landscapes, but nonetheless can provide important foraging and nesting sites. There are also areas of parkland, which include mature and potentially ancient / veteran trees, within Charborough Park, and remnants of former parkland associated with Henbury House and Henbury Hall (although much of this is now arable production). The dismantled railway has also been noted as an important ecological corridor.

7.5.5 Rivers and ponds provide important habitats for a wide range of species, including great crested newts and wetland birds. Ponds are present on either side of the old railway line South-East of Sturminster Marshall village - these are former gravel pits, the largest of which is used by anglers.

7.5.6 More information on plant and animal species recorded in the parish is included in **Appendix 4** using data supplied by the Dorset Environmental Records Centre.

Figure 11: Diagram illustrating opportunities for wildlife

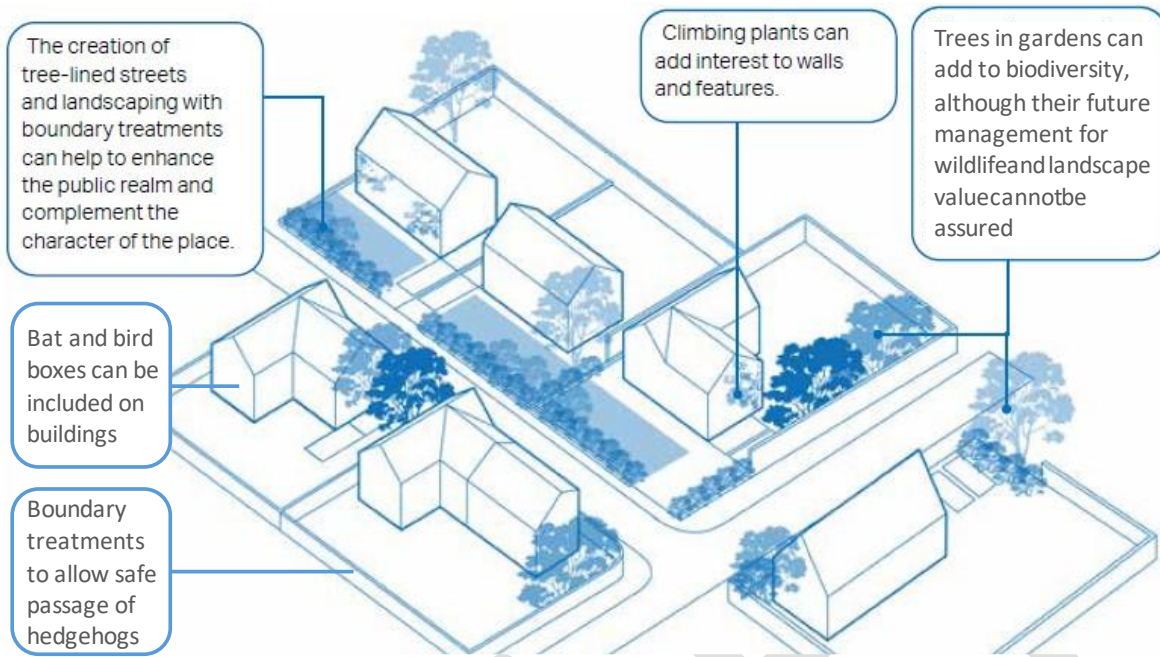

7.5.7 Development in the parish can also indirectly impact on important habitats in the wider area, including internationally important heathlands and wetland areas. In particular, development will need to include mitigation in respect of additional recreational pressure that is adversely impacting the Dorset Heathlands (and to a lesser extent, Poole Harbour) and mitigation for the increased level of nutrients from waste water that is harming Poole Harbour. Some northern parts of the parish also lie within the outer consultation zone surrounding the Bryanston Greater Horseshoe Bat SSSI. More detail on this is given in **Appendix 4**.

Policy SMNP7. PROTECTING AND ENHANCING OUR LOCAL WILDLIFE AND HABITATS

Development must protect and, wherever practicable, enhance biodiversity, starting with a thorough understanding of the existing wildlife areas and corridors (such as existing field hedgerow boundaries and streams) that are in the vicinity of the site, and the wildlife that may be affected by the development (this can be demonstrated through the submission of a completed biodiversity checklist and any necessary supporting ecological surveys). In line with national policy, a net gain in biodiversity will be sought.

Measures to support the improvement of wildlife habitats, including their resilience to climate change, will be supported.

Any development (other than householder applications, changes of use, or development that due to its limited scale and location would have a minimal impact on existing habitats) will be expected to include a biodiversity gain plan which demonstrates how a minimum 10% net biodiversity gain will be achieved, including measures taken to avoid harm to, and where practical strengthen, the network of ecological sites in the parish, through the provision of wildlife corridors and habitat enhancement. This could include:

- use of grass / sedum roofs where this would be compatible with the character of the area;
- planting native hedgerow and tree species on site boundaries and within the public realm, where possible reinforcing and linking existing green corridors;
- use of bee bricks, bird and bat boxes within new buildings and extensions / alterations;
- use of ponds, swales and other vegetated and wild-life friendly flood-mitigation features.

8. BUILT ENVIRONMENT – HERITAGE AND DESIGN

OBJECTIVES

- Achieve a better understanding of the historically important buildings and other heritage assets and how they contribute to local character. Identify the characteristic buildings and features in the distinct areas of the parish that should be retained in future developments.
- Ensure that the character of the area (including the outlying settlements) and the setting of these assets is not compromised by the presence of new developments, through the careful consideration of location, layout, scale, design and materials used.

8.1 HERITAGE – PROTECTING LOCALLY IMPORTANT FEATURES

8.1.1 People have lived in an around Sturminster Marshall for thousands of years. The name ‘Sturminster’ refers to minster (i.e. church) on the River Stour – and one of the most notable buildings in the area is the Church of St Mary, which stands on the site of earlier Saxon buildings. The ‘Marshall’ of the village name was William Marshall (1146-1219), the first Earl of Pembroke, who was one of the witnesses to Magna Carta.

8.1.2 There are 28 listed buildings in the parish, including two Grade I listed buildings (White Mill Bridge and the church of St Mary at Almer), and three Grade II* listed buildings (Henbury House, Almer Manor and the church of St Mary in Sturminster Marshall village). The historic core of the village, together with the smaller settlements of Almer and Mapperton, are designated as Conservation Areas. These designations provide significant protection to these areas and buildings, which does not need to be replicated in this Plan.

8.1.3 As part of working on the plan, the different character and history of the various parts of the parish has been explored. This has helped us understand the different styles and materials, and identify further, locally important (but unlisted) buildings and features that contribute strongly to the unique character of our area. These are listed in the sections that follow, and a fuller description is contained in **Appendix 5**. It is important that these buildings and features are conserved as far as possible, as they are an important part of the character of our area and

WHAT IS THE LOCAL HERITAGE LIST?

The local list is managed by Dorset Council, and records buildings and other assets that need consideration and protection within the planning system because of their local historic or cultural significance, but which are not statutorily listed.

Inclusion on the list is not the same as being a Listed building – there are no extra requirements or forms to complete to carry out work. But it does mean that more attention is paid in planning decisions to the impact of development on these buildings and features.



provide links to understanding its past. It is anticipated that many of these may be included in the ‘local heritage list’ held by Dorset Council, that recognises these as undesigned heritage assets.

Policy SMNP8. UNDESIGNATED HERITAGE ASSETS AND OTHER LOCALLY IMPORTANT BUILDINGS

Development should conserve and respect the contribution made by the many locally important buildings and features, as described in Appendix 5, to the character of the area, taking into account the balanced judgement on non-designated heritage assets required under national policy. Proposals which enhance or would lead to a better appreciation of these assets will be looked on favourably.

8.2 BUILT CHARACTERISTICS OF STURMINSTER MARSHALL VILLAGE

8.2.1 Sturminster Marshall village has a varied character, and there are 7 distinctive areas:

- **The Historic Core** - the original part of the village, including the church, largely reflecting the extend of the Conservation Area (that was designated in 1987)
- **The High Street** - the central part of the village extending south from the historic core as far as Churchill Close and the Bailie Gate Industrial Estate, which contains a large number of older properties as well as the school
- **Bailie Gate Industrial Estate** – the former station site with milk factory, now an industrial estate with a mix of old and new industrial buildings
- **Churchill Close** – a good example of a 1950s Council estate, set around a large recreation area, that retains much of its original character and social spirit
- **Station Road** – the main entrance to the village when arriving from outside the area, with grander buildings reflecting the Victorian and Edwardian periods.
- **Railway Drive** – also known as the Parke Lea estate – typical of the housing estates from the latter part of the 20th century with mainly detached, two storey homes and its own green space.
- **Blandford Road and Dullar Lane** – built along the busy A350 following the wider take-up of the motor car, with a high proportion of bungalows and large front gardens.

8.2.2 Outside of the village, the areas of Henbury, Almer and Mapperton, and Jubilee Cross, also have their own distinctive characters. These of these are described in more detail from section 8.3 onwards.

Map 9. Village character areas

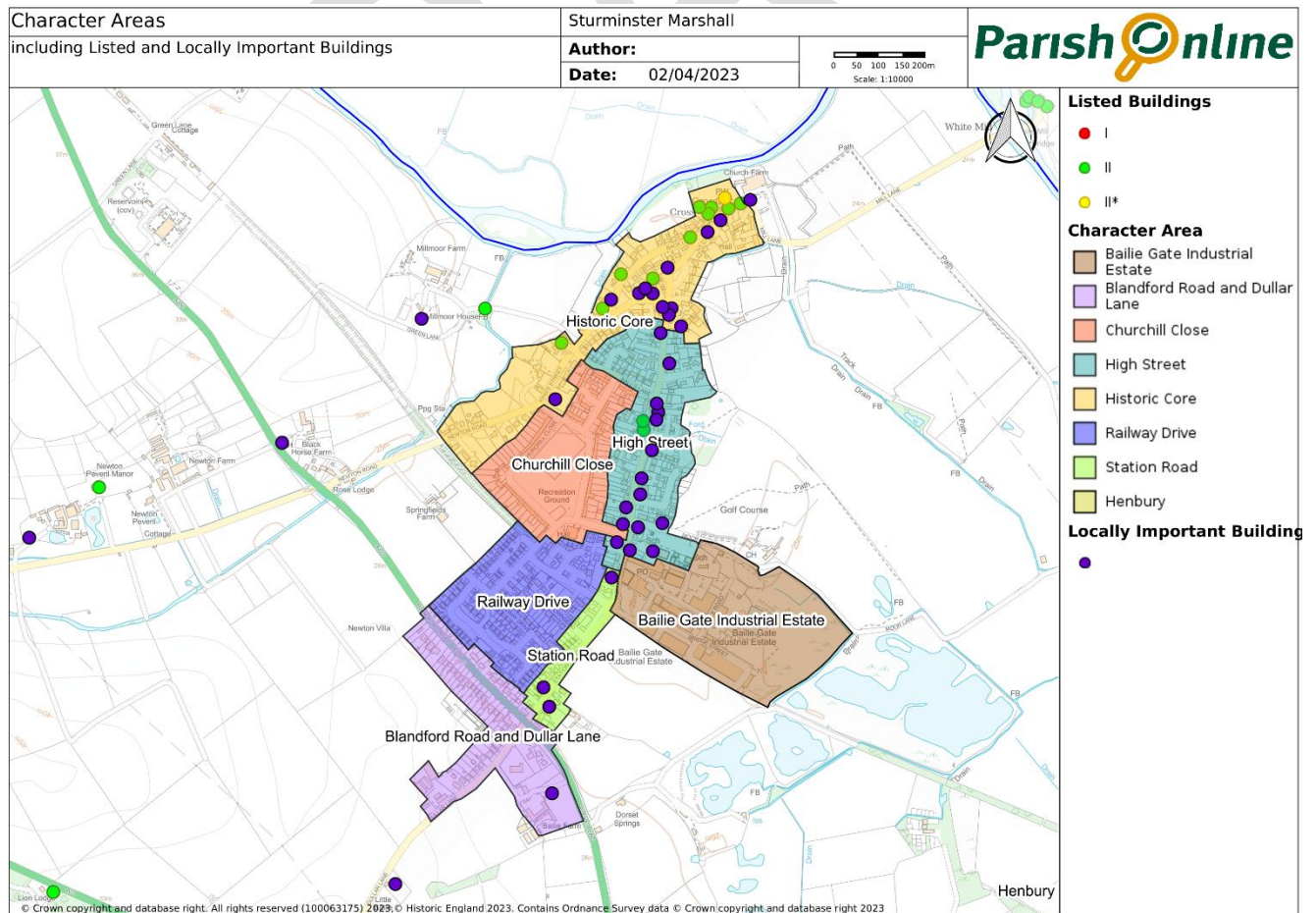

THE HISTORIC CORE

8.2.3 This part of the village is approached from the north via White Mill Bridge, the oldest bridge in Dorset. It begins as Church Street, then divides into Front Lane and Back Lane. From Market Place it continues along Kings Street towards Newton Road. It is the original part of the village and adjoins the River Stour. It was designated as a conservation area in 1987.



■ Forge Cottage, King Street

8.2.4 The area includes the following Listed Buildings:

- St Mary’s Church, Church Street
- 176-188 Church Street
- Trafalgar Cottage, Back Lane
- Maypole Cottage, Back Lane
- Waldon Cottage, Back Lane
- Stourfield, Back Lane

8.2.5 The following locally important buildings have also been identified:

- 148 and 150 High Street
- Cherry Cottage, Magnolia Cottage and the Victorian Methodist chapel
- Old School
- Red Lion PH
- Stour House
- The Red House, 140 High Street and attached barn
- Toliva

8.2.6 Additional features include:

- Johnnie’s Ditch - former village watering hole where drovers watered their flocks when passing through the village
- Pill Box, Mill Lane - concrete WW2 lookout post to protect against invasion across White Mill Bridge,
- The RAF plaque (including flag mounting brackets) on Hunters Lodge 146a High Street, to commemorate those lost in WW2
- The Maypole on Maypole Green - still used by the school for dancing, and includes the village symbol (a water rat) on the top of the pole.
- The Telephone Box on Stocks Green (now used as a book exchange)
- The War memorial at the junction of King Street and High Street
- Wheelwright’s Bonding Stone at 15 King Street - remnants of the old forge
- Sandstone stones – at Stocks Green (outside Harley House)

8.2.7 A detailed description of much of this area is contained in the Conservation Area Appraisal¹⁷.

Table 1. Historic Core – Key Characteristics and Design Principles

Street / plot pattern and building line	Narrow streets and lanes with no pavements, that have developed in an incremental, linear style, with properties either side and generally facing towards the highway. There are a variety of plot sizes and set-backs, with some buildings (particularly the older properties) fronting directly onto the lanes with no front garden, which has given them greater prominence and reinforced the historic feel of this area. There is generally a strong sense of enclosure to the lanes, reinforced by the curves and meanders of narrow village streets. At around 15 dwelling per hectare density of housing is relatively low.
--	--

¹⁷ East Dorset District Council Policy Planning Division Supplementary Planning Guidance No.13 April 2006

Building form and scale	<p>There is a mix of detached, semi-detached and terraced houses. Terraces set on traditional narrow burgage plots contrast with semi-detached and detached properties on larger plots.</p> <p>Properties do not exceed 2 storeys in height, and rooflines vary depending on typology of houses, with terraces tending to provide more uniform rooflines. Typical roofing styles include pitched and hipped roofs. St Marys Church stands out as the key landmark.</p>
Boundary treatment and public realm	<p>This part of the village has a very leafy feel to it, partly resulting from hedgerow and other vegetation being the predominant form of boundary treatment, together with the number of historic, green spaces at the various junctions and the mature oaks and horse chestnut trees. The trees along the River Stour contribute further to the leafy feel and transition with the countryside.</p> <p>Originally many boundaries marked with iron railings which still can be seen among hedging at the front of properties. In places, low stone or brick walls have been used, or buildings front directly onto the lane. Open post and rail or picket timber fences are also used, most typically where gaps onto fields occur.</p> <p>There are few pavements, particularly along the narrow lanes, meaning that the highway is shared by pedestrians and vehicles.</p>
Materials and design	<p>This area includes the Church, the Old School (1832), a public house, various thatched cottages and some Victorian villas. The age of properties primarily ranges from the early 19th century to late 20th century.</p> <p>Developments use traditional materials. Common building materials include orange-red brick, cob and white render, with timber frames and weatherboarding also featured. Red or brown clay tiled as well as some grey slate and thatched roofs. Good level of architectural detailing. Chimney stacks, painted wooden doors, multi-paned and dormer windows are also common.</p>
Key design principles for this area:	<p>Most of this area is designated as a Conservation Area, and therefore the key objective of any design decisions should be to sustain and enhance the area's character. The much more detailed Conservation Area Appraisals should be referenced in any planning decisions impacting on the historic core. The following key principles should be used as a guide:</p> <ul style="list-style-type: none"> — Reinforce the linear development pattern but vary set-backs, and use hedgerows where possible to reinforce the green character of the area — Retain gaps that allow for views to the open fields and wider countryside — Ensure a mix of house type / scale and roof forms, not exceeding equivalent of two storeys, and use of styles, materials and architectural detailing to reinforce the traditional, historic character of this area

THE HIGH STREET

8.2.8 The High Street is a mainly residential area extending south from the conservation area, along the High Street towards the present school. Features such as the old farm yard gate posts reinforce the agricultural links, and the school at the southern end of this area, built in 1911 of red sandstone brick set within beautiful grounds with plenty of outdoor space, highlights how the village evolved as it grew beyond the Conservation Area. Whilst not part of the Conservation Area, there are many older buildings that reflect the history of the village and reinforce the distinctive character of this area.

8.2.9 The area includes the following Listed Buildings:

- Holly Cottage (101 High Street)
- Keystone Cottage (105 High Street)

8.2.10 The following locally important buildings and features have also been identified (for more detailed descriptions of these see **Appendix 5**:

- 1 and 2 Mallwood, Moor Lane
- Joes Cottage (61 High Street)
- Johnnie’s Cottage (63 High Street)
- Maggie’s Cottage (65 and 67 High Street)
- Moor View (71 and 73)
- 72, 74 and 76 High Street
- Sturminster Marshall First School
- 82 High Street
- Ellen Cottage (84 High Street)
- Old Thatch (92 High Street)
- Locks Cottage and The Wing (96 and 96a)
- Lower Dairy Farm (102 High Street)
- Firenze Cottage (110 High Street)
- 114 High Street
- 116 and 118 High Street
- 128 High Street
- York House (129 High Street)

8.2.11 Additional features include:

- Cob Walls in Reeves Orchard, and at the back of Sheriden Way, Elm Gardens, which are remnants of former field boundaries from farms located in the village
- Farmyard gate posts from the original dairy farm located in the village
- Sandstone stones – at the end of Balls Lane (junction with High Street), and entrance to Sheriden Way
- White stone showing the depth of flood water on 19 January 1980, outside Firenze Cottage



Table 2. High Street – Key Characteristics and Design Principles

Street / plot pattern and building line	The area originally developed along the High Street in a linear fashion, with cul-de-sacs such as Sheriden Way formed later, as development extended to the small fields to the rear. Properties generally face onto the road, but the incremental development of plots has contributed to variations in the building line, with some properties sitting on the back of the pavement or having limited front gardens, others set much further back from the road, and some stretches where the building line is broadly consistent but with much more subtle changes.
Building form and scale	There are an eclectic mix of terraced cottages interspersed with more substantial properties, with single storey, 1½ and 2 storey properties, and gabled and hipped roofs, creating considerable variation in the roofline. Chimney stacks are seen on most roofs, mostly projecting from the centre of roofs.
Boundary treatment and public realm	Front boundary treatments include hedgerows / planting, low walls and low fencing which allows for a sense of privacy while maintaining an active frontage and reinforcing the rural character of the village. Whilst the pavement is intermittent and narrow in places, it continues on one or other side, with occasional grass verges. On-street parking is a problem, especially around the southern end of the High Street when children are dropped off and collected from school. There are also substantial trees within Bartons Ground and on the golf-course which ensure a gradual transition into the surrounding countryside.
Materials and design	The houses in the area are predominantly early 19th century with a mixture of cottages, ex farm worker’s homes, converted farmhouses and barns, providing a mix

	<p>of terraced, semi-detached and detached building types. More modern twentieth century detached properties comprise the bulk of back and infill development, but these do not dominate the generally historic character of the High Street.</p> <p>Developments use traditional materials. Materials are typically red brick, cob or white render, with brown tiles, grey slate or thatched roofs.</p> <p>Details include white rendered or red brick porches, predominantly as half porches, and small, square traditional Dorset windows with wooden cottage style front doors.</p>
<p>Key design principles for this area:</p>	<p>This area shares many attributes with the historic core, although has a greater number of cul-de-sac off-shoots where more modern infill development has taken place. The following key principles should be used as a guide:</p> <ul style="list-style-type: none"> – Reinforce the linear development pattern, with at least subtle variations in the building line – On-plot parking is recommended to avoid exacerbating the problems encountered with on-street parking. – Retain the rural character created by the hedgerows and front gardens, and visual links to the countryside, including those provided via cul-de-sac off-shoots – Ensure a mix of house type / scale and roof forms, not exceeding equivalent of two storeys, and use of styles, materials and architectural detailing to reinforce the traditional, historic character of this area

BAILIE GATE INDUSTRIAL ESTATE

8.2.12 The Industrial Estate, accessed off the roundabout on Station Road / High Street, is host to a variety of different businesses. It has developed on the site of the former milk / cheese factory, railway station and extensive sidings. There are no Listed Buildings or locally important buildings or features in this character area, with little remaining of the site's important history.



Table 3. Bailie Gate Industrial Estate – Key Characteristics and Design Principles

<p>Street / plot pattern and building line</p>	<p>Most of the roads within the industrial estate run parallel or perpendicular to the former railway line. The area as a whole has limited connectivity with the High Street (other than the main entrance). Within the estate, the industrial units are set facing the internal roads, and the differing sizes of car parks, delivery bays and areas of open storage create a degree of variety in the building line.</p>
<p>Building form and scale</p>	<p>Some of the former factory buildings have been reused, but there are extensive areas of relatively modern, industrial sheds. The buildings close to the High Street are of similar scale to the two story housing along that road, with the more modern industrial sheds set further into the site typically up to 8m in height, with differing roof styles / pitch and setbacks creating a more varied roofline.</p>
<p>Boundary treatment and public realm</p>	<p>The boundary with the High Street comprises the ends of (brick) buildings and brick boundary wall, with the open areas enclosed by metal security fencing (allowing views into the site). Trees and hedgerows line the site boundary with the countryside, but could be further strengthened.</p> <p>The internal roads are not adopted highway, and therefore there is no public realm.</p>

Materials and design	The former factory buildings tend to have red brick walls and brown clay tiled or corrugated iron roofs. The more modern industrial shed include some brick but mainly use steel cladding and roofs, some painted in colours such as green, teal and brown.
Key design principles for this area:	<p>As an industrial estate off the High Street, adjoining the countryside, much of its history is no longer apparent, and an important issue is the transition between these areas, and connectivity through the site. The following key principles should be used as a guide:</p> <ul style="list-style-type: none"> – Encourage opportunities for re-development along the western edge that would create a more positive interface with, and pedestrian access onto, the High Street – Include trees and planting within the estate, and reinforce planting along the edge with the countryside – Building heights should not exceed 8m or use flat roofs, and incorporate the installation of solar panels on roofs if practical. – Designs should be practical to enable future adaptation and subdivision / amalgamation of units to provide a range of sizes and configurations. – Building materials may either be traditional materials or more modern materials suitable for the industrial nature of the estate and promoting sustainable designs. Designs that celebrate the area’s history (as the railway station and former milk / cheese factory) are encouraged.

CHURCHILL CLOSE

8.2.13 Churchill Close was originally built by the local authority in the 1950s for the workers of the cheese factory and is centred around a large green space. The avenue of lime trees running from the High Street were planted in 1951 to commemorate the Festival of Britain.

8.2.14 The area does not include any Listed Buildings. However it has a very distinct character linked to the immediate post-war period that is considered to be unique to the village, and should be considered a non-designated asset in its own right.





Table 4. Churchill Close – Key Characteristics and Design Principles

Street / plot pattern and building line	Properties along Churchill Close are organised in a linear style around a large recreational greenspace, creating a very uniform building line (with very subtle, symmetrical changes to provide visual interest), plots sizes and spacing.
Building form and scale	Buildings are predominately terraced and semi-detached, with repeated style and layouts, typical of immediate post war housing. Buildings are mainly 2 storeys in height (with single storey links between groups of terraces). There is a single storey complex of bungalows to the north side of the character area, which have been developed slightly later. The use of standard house types (and scale) creates a broadly continuous roofline, regularly punctuated by chimneys and single storey links, and with very subtle, symmetrical changes in height (within terraced blocks and pairs) to provide visual interest.
Boundary treatment and public realm	The boundary within the character area is typically defined by low brick walls or vegetation, with pavement to the front. The public realm is dominated by the large green area which is in the centre of the character area. The grass verges along either side of the road leading from the High Street, and on one side connecting to Balls Lane, are planted with an avenue of trees.
Materials and design	Uniform designs using pitched roof, broad casement windows and square, flat-roofed porches. Red and painted off-white brick, brown clay roof tiles with red crick chimneys.
Key design principles for this area:	This area has a very distinct character linked to the immediate post-war period that is considered to be unique to the village. Further built development or replacement dwellings within this area is not encouraged, as it is likely to compromise the unique, planned character of this estate. The following key principles should be used as a guide: <ul style="list-style-type: none"> – Any development should respect the unique character of the planned 1950s estate, including the characteristic building line, height, rhythm and materials, and the use of communal green spaces

STATION ROAD

8.2.15 Station Road is the main entrance to the village off the A350, linking up to where the former railway station stood, and characterised by large, typically individual, detached houses on one side, and green open fields to the other.

8.2.16 There are no Listed Buildings in this character area, but the following locally important buildings have been identified:

- Churchill Arms - *whilst this building is now scheduled for demolition, it remains part of the area's history.*
- Baillie Leaze, 8 Station Road
- 11 and 15 Station Road.



Table 5. Station Road – Key Characteristics and Design Principles

Street / plot pattern and building line	Properties face onto the street, but are generally set back from the road, typically by about 5 – 7m, giving a broadly uniform building line, although subtly varied due to the different building forms and incremental stages of development. Plot sizes are comparatively generous with good-sized front and back gardens.
Building form and scale	Buildings are mainly large detached houses, generally 2 storeys in height (though there are some bungalows, and examples of 2½ storeys or the use of roof space for accommodation). Differing roof styles (typically pitched or hipped) and chimneys (particularly in the older buildings, projecting from the centre or sides of the roof) create considerable variation in the roofline.
Boundary treatment and public realm	The main road is relatively wide, with pavements on either side. Low brick walls and vegetation with decorated front gardens create a green feel to properties along the western side of Station Road. On the eastern side, there is a significant stretch that remains undeveloped, with green fields behind a hedgerow, providing an important visual relationship with the wider countryside. On-street parking is an issue, despite laybys having been provided on the eastern side of the road opposite the local shop, and on-plot parking is recommended.
Materials and design	Materials are largely red brick or white paint / render walls, with pantiles or grey slate tiled roofs, and brick chimneys. A number of dwellings have decorative ridge tiles (e.g. half tiled semi-circular terracotta tiles across the main ridge), decorative finials, and stone mullioned window sills. Sash windows are predominantly used. Properties tend to have been individually designed, and include several Victorian and Edwardian style villas. The use of bay windows and slightly protruding gables and porches provides further interest to the street scene.
Key design principles for this area:	The grander and more spacious feeling of this approach road into the village, reminiscent of its hey-day when the railway station and related industries generated local prosperity, are a key driver in the design approach to this area. The following key principles should be used as a guide: <ul style="list-style-type: none"> – Respect the linear pattern with properties facing onto the street, within generous sized plots and set-backs – On-plot parking is recommended, to avoid exacerbating problems associated with on-street parking in this location – Retain the visual link to the open countryside to the east – Building heights may extend to 2½ storeys, subject to there being sufficient space

	<p>around the building, including landscaped front gardens. Use hedges, metal railings and low bricked walls along the street boundary</p> <ul style="list-style-type: none"> – Development should generally use traditional materials, and be designed with architectural detailing to reinforce the importance of this road in the prosperity of the village and links to the railway era.
--	---

RAILWAY DRIVE

8.2.17 The Railway Drive character area was mainly built in the late 20th century (with the exception of Townsend where building took place in the first half of the 20th century). As such it reflects the typical large-scale, estate-style developments that were widespread at that time. There is little scope for further development within this area, particularly in the large, planned estates which are relatively modern.



8.2.18 There are no Listed Buildings or locally important historic buildings identified in this area.

Table 6. Railway Drive – Key Characteristics and Design Principles

Street / plot pattern and building line	The Railway Drive area is an estate style development, with a mix of broadly straight roads and gently curving roads and cul-de-sacs. The properties in the character area generally face into the street, have a similar setback of approximately 5m, but subtle variations in the house types, set back and road alignment creates some variation in the building line. Overall, the density of development is reasonably consistent at around 20 dwellings per hectare.
Building form and scale	Buildings in the area are typically 2 storeys (and of a similar scale), semi-detached and detached family housing, with a mixture of pitched, hipped and half-hipped roofs, most of which have chimney stacks that project from the edge of roofs.
Boundary treatment and public realm	Boundary treatments comprise a mix of fencing, hedging and dwarf walls which overlook the street. The streets generally have pavements on either side, with street lights, and seemingly good levels of on plot parking, so that on-street parking is not a problem. A large mainly grassed green space is provided within the estate, creating opportunities for people to enjoy and meet outside.
Materials and design	Red brick is the most common material, but there is also brick and flint (in bands) and the occasional use of cream render or tile hung on the first floor facades. Brown clay tiles or grey slates are generally used for roofing. Windows generally have a vertical emphasis, with gabled dormers or half gabled ‘eyebrows’ commonly used. A mix of closed and open gable / and pitched porches and other decorative elements adds interest.
Key design principles for this area:	Whilst there is little scope for further development within this area, the following key principles should be used as a guide:: <ul style="list-style-type: none"> – Development should reinforce the character of the estate, particularly with reference to the building line, pattern and density of development. – The scale of development should not exceed two storeys in height, and building materials should reflect the general colour palette found within the estate. – Opportunities to strengthen biodiversity and green spaces / corridors, together with improved footway links to the surrounding area, should be taken where

	<p>possible.</p> <ul style="list-style-type: none"> – The retention of on-plot parking is recommended, particularly on the main routes into the estate.
--	--

BLANDFORD ROAD AND DULLAR LANE

8.2.19 This area is the part of the village experienced by travellers along the busy A350. It was mainly developed after the Second World War. The Baillie Cross garage and petrol station to the east of the junction of Station road closed in the 1990s, and has been replaced by a row of terraced properties. The absence of a pavement along Dullar Lane and safe pedestrian crossing point of the busy A350 would make further building within this character area, particularly to the south, problematic.

Figure 12: Baillie House on Poole Road (below)



Figure 13: Bungalow on Dullar Lane



8.2.20 The area does not include any Listed Buildings, but Baillie House is considered to be a locally important historic building.

Table 7. Blandford Road and Dullar Lane – Key Characteristics and Design Principles

Street / plot pattern and building line	Development is primarily along the A350 and up Dullar Lane, centred around the junction with Station Road. Buildings face onto but are set well back from the road (between 5 and 10m) with generous front gardens that allow for on plot parking and turning, and gaps between buildings allowing views towards the countryside.
Building form and scale	There is a mix of single storey bungalows, chalet bungalows and 2 storey homes (the latter focused around the crossroads). Many properties have dormer windows and most have chimney stacks projecting from the centre or sides of the roof, adding subtle variation to rooflines. Most are detached, but there are some semi-detached houses and one terrace of three (on the former garage site). The predominance of bungalows together with the larger plots and set back provides a spacious feel to this area.
Boundary treatment and public realm	An equal mix of hedgerows and red brick walls, but the generous front gardens mean that vegetation dominates the boundary treatment, adding to the rural feel to the area. There are footpaths either side of the main road, but not in Dullar Lane or along the stretch of road where the properties in Railway Drive back onto the A350. The high levels of traffic detract from the enjoyment of the public realm.
Materials and design	Walls are typically red brick or white render, with red, brown (and occasional grey) tile roofs, and grey slate, some with red clay tile ridges. Some of the older buildings have architectural detailing on them as well, mostly consisting of red and yellow brick patterns to frame doorways. The more recent development on the garage site as

	attempted to emulate a typical Dorset cottage style and includes brick and flint banding.
Key design principles for this area:	<p>The following key principles should be used as a guide:</p> <ul style="list-style-type: none"> – Development should follow the linear pattern of development, with properties facing onto the road, and on-plot parking within generous front gardens (or where this is not possible, provided to the side or rear). – Consideration should be given to the design of development at the entrance to the village and junctions to reinforce this area’s relationship to the rest of the village. – Opportunities should be taken to enable tree and shrub planting along the A350 to enhance its rural character and mitigate the impact of traffic on the character and amenity of this area. – Opportunities to provide safe pedestrian connections into the heart of the village should be explored. – The scale of development should respect that of neighbouring properties, not exceeding two storeys in height, with gaps retained to provide views out to the wider countryside.

8.3 BUILT CHARACTERISTICS OF THE WIDER COUNTRYSIDE AND HAMLETS

8.3.1 The countryside in the wider parish comprises a mix of farmland and woodland, as well as sand and gravel workings, a golf course and fishing lakes. The main settlements in the area are Henbury to the east, Jubilee Cross to the south, and Almer and Mapperton to the south-west, together with various farmsteads, farm workers cottages and isolated homes.

8.3.2 In the wider countryside around Sturminster Marshall, Church Farm, Millmoor House, the Goldon Fox, Newton Peveril Farmhouse and Little Bailie are identified as locally important historic buildings. Descriptions of these are included in Appendix 5. A pump house, now overgrown, in the Gladwich Fields is all that remains of a WW2 experimental radar facility.

Map 10. Character areas across the wider parish

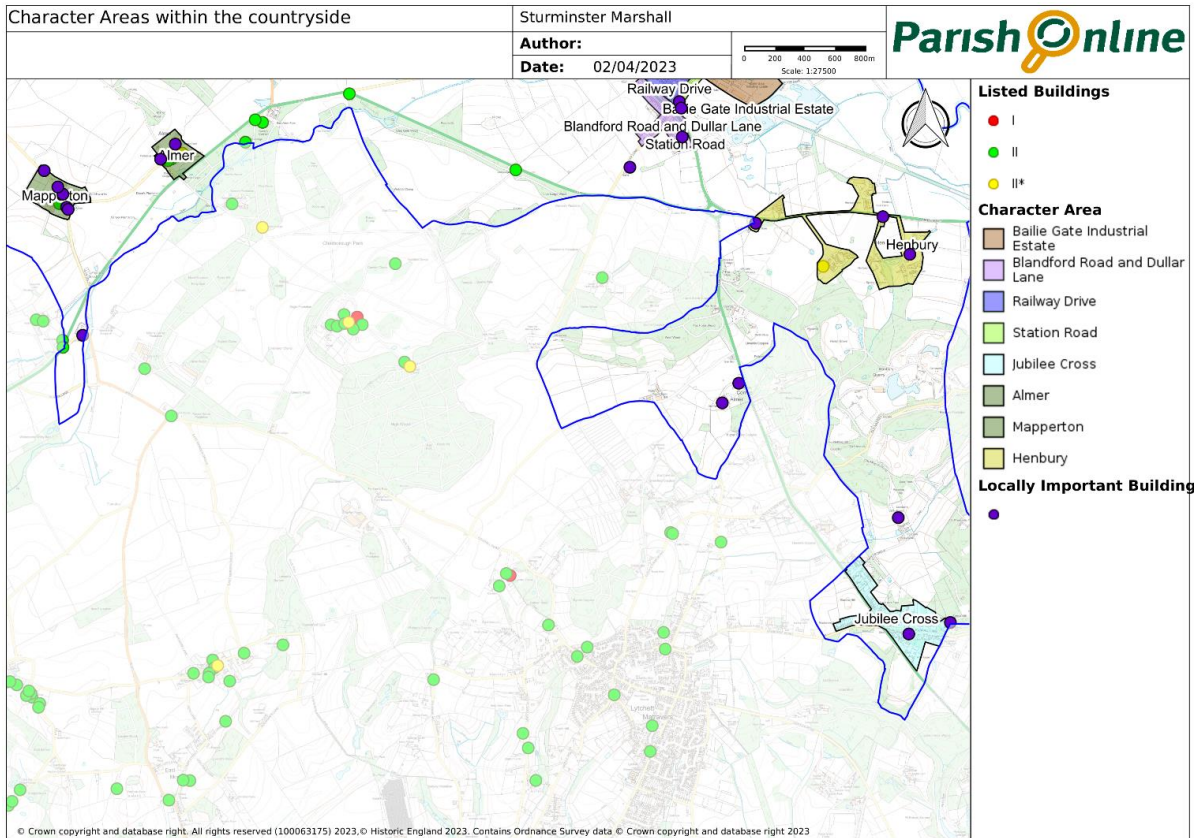

HENBURY

8.3.3 Henbury is a collective name for the clusters of development that lie either side of the A31 to the east of the parish. According to Hutchins (the author of the History and Antiquities of the County of Dorset, 1869), Upper Henbury was a manor (Henbury Manor) and hamlet situated in a pleasant vale about a mile and a half south of Sturminster Marshall. Lower Henbury, another manor (Henbury House) and hamlet lay about half a mile to the west and was part of a separate estate. Maps dating back to the turn of the century indicate large areas of parkland around Henbury House and Henbury Manor, with tree-lined avenues marking their approach from the main road. The area to the south side of the A31 retains clear links to the importance of these buildings and parkland attributes.

8.3.4 Permission was granted in the 1990s for residential development immediately to the east of Henbury House in order to fund the extensive repair and restoration works required to save the building (Grade II* Listed) from collapsing, due to the serious defects related to subsidence. It had previously been used as a restaurant and hotel, but neither venture had been successful to cover the cost of the works.



8.3.5 On the north side of the A31 there is a small industrial estate that has developed from original farm buildings associated with Henbury Farm, and Vines Close farm shop and café have similarly evolved from a former agricultural site.

8.3.6 Henbury House (also known as Henbury Hall) is the only Listed Building within this character area - a Georgian country house dating from the 1700s. The following locally important historic buildings and features have also been identified:

- Henbury Cottages
- Henbury Manor
- Vines Close House

8.3.7 In the wider countryside around Henbury, Old Farm and the pair of Victorian cottages (1 and 2 Coombe Farm Cottages) off Poole Road are identified as locally important historic buildings linked to the Henbury House estate land.

Table 8. Henbury – Key Characteristics and Design Principles

Street / plot pattern and building line	Dispersed, and limited amount of development focused on the two former manor houses and farms – and giving a rural / parkland feel to the area. Plot patterns (in size and orientation) are varied, and most of the development does not relate to the main road but to the former manor houses and farms that are set well back.
Building form and scale	The two manor houses (and associated Dower house) are substantial properties, (Henbury House being the largest at 2½ storeys plus basement), but otherwise most buildings are mostly two storeys or single-storey farm buildings. Typical roof profiles include hipped and pitched roofs, hip and valley roofs and double pitched roofs.
Boundary treatment and public realm	The area is rural in character, with hedgerows, trees and shrubs as typical boundary treatments. The entrance features and tree-lined lanes connecting to the former manor houses help to emphasise the historic importance of these properties and their estates. Farm yards (now in a range of employment uses) are more likely to use metal gates and fencing, which would benefit from some landscape buffering to soften the visual impact of some of the more industrial buildings.
Materials and design	Properties are largely red brick, some of the historic farmhouses are decorated with interesting architectural detailing and patterns. Dormer windows and red brick chimney stacks also feature. Roof materials include red and brown clay tiles, and some grey slates. Farm / industrial sheds tend to be built more simply with materials such as iron sheet panelling, and low-pitched corrugated iron roofs.
Key design principles for this area:	Given this area is washed over with Green Belt, it is unlikely that there would be scope for additional buildings in this location. The following key principles should be used as a guide: <ul style="list-style-type: none"> – The extension or replacement of existing buildings should not result in disproportionate additions over and above the size of the original building, or be materially larger than the one it replaces. – The design and character of development should respect the historic importance of the manor houses, associated (but clearly subservient) buildings, their parkland setting, and the role of the farms, in shaping the development of this area.

JUBILEE CROSS

8.3.8 The hamlet of Jubilee Cross developed around the crossroads (now slightly offset) formed by the Poole Road, Wimborne Road and Rushall Lane. The car garage on the corner emphasises the strong role of the motorcar in this settlement's location, and much of the development has taken place incrementally on the former sand and gravel workings.

8.3.9 The area known as Crumpet's Farm Drive was divided up into 16 plots well before the second world war, to house resettlement families (and this area therefore pre-dates most of the properties in Jubilee Cross) - today these plots are characterised by a mixture of chalets and caravans.

8.3.10 Along Rushall lane, the houses are large detached properties, unique in design, brick built and/or rendered and set back in substantial gardens. On Poole Road and Wimborne Road, the buildings are individual in style, many originating as bungalows in large gardens and are on one side of the road only with fields opposite and around. Over time a number of these bungalows have been extended and enlarged into chalet style residences.

8.3.11 The area does not contain any Listed Buildings, but the following locally important historic buildings and features have been identified:

- Forest Hill House.
- Stoney Down Pottery (Jubilee Cottage).

8.3.12 In the wider countryside north of Jubilee Cross, Crumpets Farm has been identified as a locally important historic building.



Figure 14: Stoney Down Pottery (Jubilee Cottage).

Table 9. Jubilee Cross – Key Characteristics and Design Principles

Street / plot pattern and building line	Mainly ribbon style development, with properties set well back from the road (including an elevated bank with hedgerows and access lane along Poole Road providing an effective buffer to the highway). Plot sizes are comparatively large, with generous front and back gardens, allowing plenty of parking within the plot. Building lines are reasonably regular along Poole Road and Wimborne Road, but vary more along Rushall Lane, particularly in orientation.
Building form and scale	Buildings are typically detached, either 2 storeys or bungalows (many of which have extended into the roof to form chalet bungalows). Roofs vary including hipped, gabled and cross-gabled styles.
Boundary treatment and public realm	This area is characterised by the many large trees that are found along the highways and within the large gardens, which allows buildings to blend in with their rural setting. Boundary treatments are varied but grass verges, hedgerows, shrubs and trees provide the most appropriate treatment given the rural character of Jubilee Cross. Pavements are intermittent but are much needed given the traffic volumes and speed.
Materials and design	Red and buff brick, and off-white render, are common building materials. Some properties incorporate clay hung tiles on facades and some are decorated with red brick patterns or timber frame. Typical roofing materials include red and brown clay tiles, with some grey slate. Dormer windows and chimney stacks are common, adding interest to the rooflines.
Key design principles for this area:	<p>This area is washed over with Green Belt but may be suitable for some limited affordable housing. Otherwise, it is unlikely that there would be scope for additional buildings in this location other than the extension or replacement of ones (which would be limited in size). The following key principles should be used as a guide in considering options for affordable housing:</p> <ul style="list-style-type: none"> – Development should follow the linear pattern relating to the main roads, or if to the rear should be accessed via the create of a rural track. – On-plot parking is recommended, as on-street parking would not be appropriate in this location. – Building heights should not exceed 2 storeys.

- Development should reinforce the rural character through retention and planting of trees and greenery along lanes and to the rear. Plot sizes (or the space surrounding built development) should be sufficient generous to retain the rural character of the area.

ALMER AND MAPPERTON

8.3.13 Almer and Mapperton are two hamlet on the south-western edge of the parish, close to the boundary of the Charborough Estate (owned by the Drax family). Almer consists of a cluster of buildings around the manor and church. Mapperton is centred on another farm and the former Rectory.

8.3.14 The area includes the following Listed Buildings:

- Mapledretone House (formerly listed as The Old Rectory) – a substantial, red brick building with stone arches and a tiled roof, plus stone tiles to the lowest courses. There are hipped dormers and a mixture of sash and casement windows
- Church of St Mary (the churchyard cross and a tomb are also Listed separately)
- Almer Manor

8.3.15 In terms of locally important historic buildings, the following are noted:

- Fortescue House, Almer - described in the Conservation Area as a well-proportioned modern house, with a symmetrical front and a central porch, facing the road.
- Various traditional barns and farm buildings within Almer, which although of mixed architectural merit individually, are important as a group.
- No.s 17 and 18, Mapperton - a pair of small Victorian semi-detached villas of brick and slate, with a prominent central chimney stack
- Mapperton Farmhouse, Mapperton – farmhouse with some cob walls but largely extended in the early nineteenth century with brick and stone. The entire roof, formerly thatched, is now tiled. Associated traditional barns to rear also of local importance
- Thatch Cottage, Mapperton - a cob and thatch cottage south-east of Mapperton Farmhouse
- No.s 29 and 30 Mapperton - part brick and part rendered, under a half-hipped tiled roof, with dormer windows, facing away from the road
- Dairy House, Mapperton - nineteenth century brick and tiled house, symmetrically built with a simple, central doorway

Table 10. Almer and Mapperton – Key Characteristics and Design Principles

Street / plot pattern and building line	The hamlet of Almer is centred on the Church and Manor. The hamlet of Mapperton is centred on the farm and the Old Rectory. They are accessed via narrow, rural lanes, and have a relatively spacious quality with generous plots. Given the very low density of buildings, there is no recognisable building line.
Building form and scale	The key buildings (church, manor and former rectory) stand out in form and scale, with the remaining buildings either single storey farm buildings of varying scale or farm worker’s cottages.
Boundary treatment and public realm	Plot boundaries are generally brick / brick and flint walls or hedgerows, with comparatively generous grass verges. Key spaces including the churchyard and pond in Almer, and the gaps between buildings in Mapperton. The wider farmland and woodland setting and many mature trees (such as the roadside oaks) are also important.
Materials and design	The Church of St Mary is architecturally distinctive for its ironstone rubble and limestone band facade, and tiled roof with stone slates at verges. Similarly, Almer

	Manor is also distinctively built with bands of limestone and flint. Otherwise most properties are built with red brick, including the traditional brick and tile farm buildings, and some examples of cob / off-white render, and traditional thatched roofs. White framed sash or casement windows. The styles generally reflect the farming traditions and the period in which they were built.
Key design principles for this area:	Both hamlets are designated Conservation Areas, and therefore the key objective of any design decisions should be to sustain and enhance the area's character. Given the rural nature and heritage importance of both hamlets, it is not envisaged that there would be much development within this area. The much more detailed Conservation Area Appraisals should be referenced in any planning decisions impacting on these hamlets

8.3.16 The Worlds End Public House lies to the south - once the oldest pub in Dorset until a fire razed it to the ground in the early 1990s, since rebuilt retaining much of its original character. There are further Listed Buildings within East Almer (East Almer Farm, East Almer Lodge and Marsh House).



Figure 15: The World's End Pub

8.4 APPLYING THE DESIGN PRINCIPLES TO DEVELOPMENT

Policy SMNP9. KEY DESIGN PRICIPLES:

Development is expected to follow the key design principles of the character area in which it is based, together with the general design principles set out in Policies SMNP10 - 13. Where a design and access statement is required, this should explain how these principles have been followed.

LAYOUT - STREET / PLOT PATTERN, BUILDING LINE AND ORIENTATION

8.4.1 In general, the historic form of the built-up parts of the village of Sturminster Marshall follows a linear pattern, with gently curving lanes, of moderate-sized plots and dwellings with gaps (a low to medium density). Development in the latter part of the 20th century has echoed the national trends at that time towards estate-style development, but is not necessarily a pattern that should be continued on other sites. As a result, there are three main street types in the village:

- **Main access streets**, connecting through the village – primarily the High Street and A350 – which need to cater for the higher level of traffic / movement. These routes are also critical in terms of how the village is perceived. They benefit from incorporating green verges and street trees where possible, to provide shade and reduce the adverse impacts of on-street parking. Attention also needs to be given to the 'gateways' and main junctions - the curved frontage (as per A350 / Newton Road junction) and the curved approach at Church Farm at the northern end of the village) add charm and interest.

- **General streets** within the village that are not part of the main access routes, such as Railway Drive and Churchill Close. These types of street benefit from measures to ensure they keep traffic speeds below 20mph, with unimpeded street lengths kept to a minimum. They also benefit from green verges and occasional street trees, and landscaped front gardens (with parking primarily provided to the side of the property). Layouts work better where they are permeable (rather than multiple cul-de-sacs that limit route choices, particularly for pedestrians and cyclists).
- **Edge lanes** act as a transition between the village and surrounding countryside, such as Back Lane. These are less built up, potentially with greater 'porosity' or gaps in the building line adjoining the countryside, providing interest and evolving views. These should have a more rural character, without kerbs or pavements (particularly on the edge adjoining the countryside) and hedgerow boundaries. Here the lane width can vary to discourage speeding and introduce a more informal and intimate character. Swales may be an appropriate feature to address any flood issues.

8.4.2 Whilst there are few street trees at present (other than in the larger green spaces), the incorporation of more street trees would have a beneficial impact and is encouraged. Existing mature broadleaf trees should be retained.

Figure 16: Illustrated street section that can be considered in new development, showing different setbacks

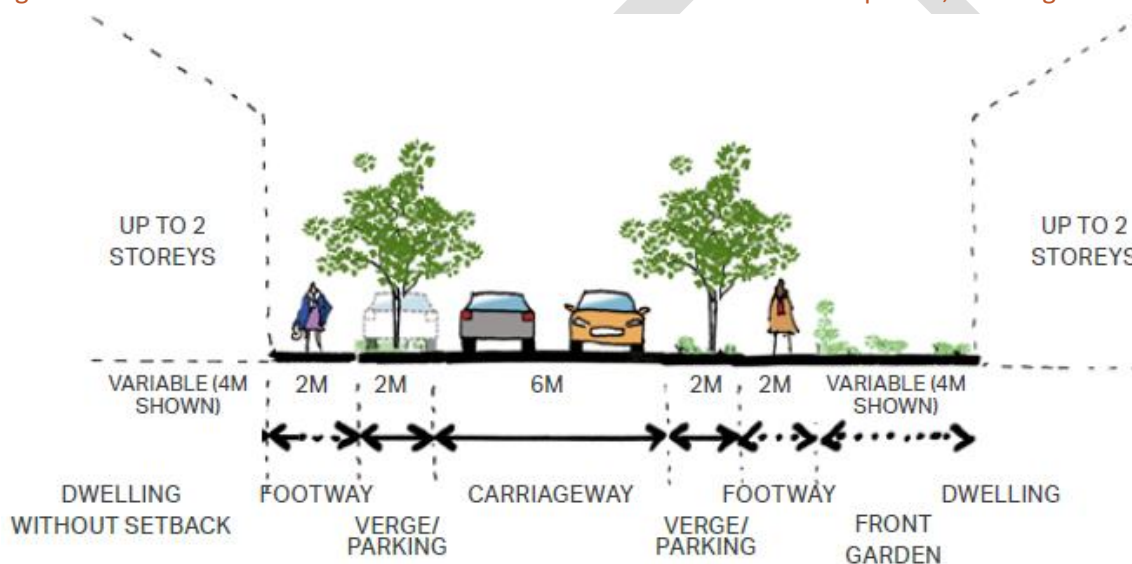

8.4.3 Buildings tend to front onto the highway and public spaces, with doors, windows and front gardens all providing a degree of interest and surveillance of the public realm. Rear boundaries facing the street (such as where Railway Drive backs onto the A350) should be avoided as this does not contribute to the character or public surveillance (so making the area feel less safe).

8.4.4 It should be possible to ensure that most properties are aligned so as to accommodate solar panels (ideally integrated as part of the tiles), as well as benefiting from solar gain by including larger glazed elements on the southerly aspects.

Policy SMNP10. DESIGN PRINCIPLES - LAYOUT

As a general rule, the street layout and plot patterns should conform to the following principles:

- Strong linear development following the main routes;
- Clear indication of safe pedestrian routes, through the use of dedicated footways within the highway where feasible;

- Street trees should be included where feasible. These should be placed with at least a 1m clearance of the footway or carriageway, away from below-ground utilities, and should not block key view corridors or sight lines;
- Existing mature broadleaf trees should be incorporated into the layout of development as part of the landscape design, using them as accents and landmarks where appropriate;
- Buildings face towards the road creating an active frontage. The orientation and internal layout will also need to consider the placement of solar panels and glazing to reduce heating demands;
- Variety of plot patterns and subtle variations in the building line (with the exception of the Churchill Close character area). The degree of set-back will depend on the character of the area and provision of parking, but should include sufficient space for planting / front gardens so that the character of the area remains green;
- Gaps between dwellings retain glimpsed views to the wider countryside.

Particular care should be taken in the design and layout of buildings at key junctions / approaches to the village, to create a distinctive and inviting space that should be attractive and welcoming to visitors.

Consideration should be given to the use of landmark elements (for example, a distinctive building, public art, or sizable trees within an area of green space) together with fingerposts (in character with local signage) to help visitors find key route connections and community facilities. Given the relatively flat nature of land within and around the village, such views are likely to be relatively short, but can be connected as a sequence.

BUILDING FORM AND SCALE

8.4.5 Building forms vary, but reflect the rural nature of the area, including obvious links to farm workers (cottages) and farmhouses. They also emphasise the importance of the railway in bringing both industry and trade in the early 1900s. Building heights range from bungalows and outbuildings (single storey), cottages and chalet bungalows (1½ storeys or the equivalent in scale) up to 2 storeys houses (and similarly scaled industrial sheds), with occasional (and typically grander) buildings of up to 2½ storeys.

8.4.6 Where development is proposed within an existing character area, its form and scale should reflect the characteristics and variety found in that area. This will mean that certain types of development are unlikely to be appropriate. For example, the area does not contain examples of town houses and flats / apartment blocks, which would be wholly out of keeping with the character of the area. This should not prevent the provision of small (1 bedroom) apartments, which could be made through the subdivision of properties that have the appearance of some of the larger properties found in the area, or as courtyard type developments.



8.4.7 Roof forms also vary, but generally include pitched or hipped areas (that unless thatched, would lend themselves to the incorporation of solar panels). Whilst flat roofs should be avoided (as they are not in keeping with the character of the area), innovative designs integrating green (grass / sedum) roofs may be suitable, including on outbuildings, as these should further green the environment and contribute to biodiversity.



8.4.8 Care needs to be taken in considering the scale and form of extensions to buildings, to ensure that changes do not overwhelm, unbalance or otherwise detract from the original design and its relationship with adjoining buildings, including the contribution of the gaps between buildings to the character of the area and glimpsed views of the countryside. Consideration will also need to be given general good design principles on privacy, light and amenity for neighbouring residents.

Policy SMNP11. DESIGN PRINCIPLES: BUILDING FORM AND SCALE

As a general rule, the scale and form of buildings should conform to the following principles:

- Building heights should be between 1 and 2 storeys (with 2½ storey buildings being the exception), at an equivalent height to similar buildings found in that character area.
- Where development is proposed within an existing character area, its form and scale should reflect the characteristics and variety found in that area.
- The scale and form of extensions must not overwhelm, unbalance or otherwise detract from the original design of the host building, and its relationship with adjoining buildings.

BOUNDARY TREATMENT AND PUBLIC REALM

8.4.9 The boundary treatment and public realm in Sturminster Marshall help reinforce the green, rural character of the area (including within the industrial areas). In general, the amount of vegetation is usually higher towards the periphery of the settlement. Hedgerows (or well-placed shrubs) and low, red brick boundary walls are the predominant boundary treatments, with metal railings also used in places. The use of boundary treatments is helpful in defining private areas from the public realm, but the use of high boundary walls would detract from the character of the area and tends to reduce the passive surveillance of the public highways and green spaces, and so should be avoided. Similarly, development with a hard edge which imposes an abrupt transition from the settlement to the surrounding countryside should be avoided.

8.4.10 The provision of green spaces, which can be used by the public for socialising and informal recreation, are important both for the green character of the area and people's health and well-being. These don't tend to be managed (there are no formal parks) but may include play equipment, benches and other similar features, and tend to include large broadleaf trees. The current Local Plan Policy HE4 recommends that there should be accessible green spaces (for recreation, play and amenity) within 450m of people's homes, and should major development be proposed, the provision of green spaces as part of that development will be required.

8.4.11 Landscaping schemes should seek to accommodate large tree species to have the greatest positive long-term impact, and their anticipated canopy size and root zone should be taken into account in the layout. They should also take into account flood issues in the area, which may benefit from the use of swales and holding ponds, and use permeable surfaces.

8.4.12 The storage of waste bins should also be considered as these can have a detrimental impact on the public realm, both visually and creating problems when left out. Ideally, storage areas should be designed and included for each property, placed conveniently to the collection point, and designed in a manner which is unobtrusive and does not detract from the green character provided by the hedgerows, shrubs and trees within the highway and front gardens.

Policy SMNP12. DESIGN PRINCIPLES: BOUNDARY TREATMENT AND PUBLIC REALM

The design of boundary treatments and the public realm in Sturminster Marshall should generally conform to the following principles:

- Boundary treatment of road frontages should be used to reinforce the linear form and rural character of the street layout, through the retention and use of native hedgerows, traditional low boundary walls and metal railings. Close-boarded wooden fences and high boundary walls should be avoided adjoining the highway, public realm and settlement edge (with the countryside). Verges with planting strips should be used to enable shrubs and climbing plants to be used to screen features such as garages, blank walls and fences where these cannot be avoided in the street scene.
- Arrangements for waste storage and collection should be clearly set out and integrated within the plans in a manner that does not detract from the vegetated, rural character of the street scene.
- Green spaces for amenity and informal recreation should be included within residential areas in line with the open space standards covering recreation grounds and public gardens, children and young people's space and amenity green space as set in the Local Plan. These should be designed as a central part of the development, and where practical combined to enable the incorporation of large tree species and flood attenuation / drainage features as part of their design.

MATERIALS AND ARCHITECTURAL DESIGN

8.4.13 There are a variety of architectural styles within Sturminster Marshall, spanning over several centuries. This includes cottages, mostly thatched, dating from 17th century, Victorian brick and slate villas, which stem from opening the railway, 1960s post-war housing, as well as late 20th century estate and more recent infill developments.

8.4.14 The majority of materials are soft orange / red brick, with white / cream render (historically cob) and whitewashed bricks also relatively common, under red or brown clay tiles, grey slate or thatched roofs. There are also isolated examples of other materials such as banded flint, ridged / Roman tiles and weatherboarding, and timber frames. Multi-paned sash, casement and bay windows are also common to many of the character

Fenestration



Casement window



Sash window



Bay window



Sash window and white decoration around the window



Window with external shutters



Casement window



Wooden door



Thatched porch



Wooden door

LIFE CYCLE ASSESSMENT

Life Cycle Assessment of materials looks not just at the embodied energy, but the resulting environmental impacts and process emissions throughout the supply chain and life cycle.

This has led to the development of “Environmental Profiles” for construction products, first published by the Building Research Institute (BRE) and is used within EcoHomes to assess the Mat 01 credit.

Road, where this differs). The industrial units tend to be more practical using steel / corrugated iron elements, although the railway / milk factory heritage can still be recognised in the older buildings. Different building materials will have different environmental properties. For example, locally sourced / recycled materials will tend to have lower embodied energy, but may have also have a low thermal mass (the ability of a material to absorb, store and release energy, which can help retain heat in the winter, and keep buildings cooler in the summer). Where thermal mass is low, additional insulation may be required. The environmental properties of material should be considered and may justify the inclusion of materials not currently found in the area – but which may still be compatible within the overall colour palette.

areas, generally with white frames, and square or vertically proportioned (although there are some areas – such as in Churchill Close and Blandford

Colour palette



8.4.15 Solar panels can now be built with the appearance of slate and, using new technology, the industry is also making advances in creating solar tiles that can take on the appearance of other building materials such as clay tiles. Green (grass / sedum) roofs can also be considered.

8.4.16 Homes should also be designed to avoid overheating, with consideration given to the potential for natural ventilation, and the use of roof overhangs and deep window reveals to provide shading in the hottest months when the sun will be more directly overhead.

8.4.17 The design of the building should provide visual interest, appropriate to its context (i.e. the nature of the building and its location). Porches are a common feature on many residential properties, and provide visual interest / variation in the street scene as well as shelter from the elements. Their design is generally suited to the house style and materials. Gabled dormers / half dormers are also relatively common. Chimneys also add interest to the and are generally brick – whilst these may not be needed functionally in the traditional sense, they provide opportunities for ventilation systems to be integrated into the design. On older buildings the roof overhang casts a shadow on the buildings and windows tend to be slightly recessed with protruding sills, creating visual interest and change as the light alters.

8.4.18 Dorset Council now requires a sustainability for all planning applications for new buildings, setting out how sustainable design and construction have been addressed, including reducing energy consumption and carbon emissions, minimising waste and increasing recycling, and maximising the use of sustainable materials and adaptation to Climate Change¹⁸.

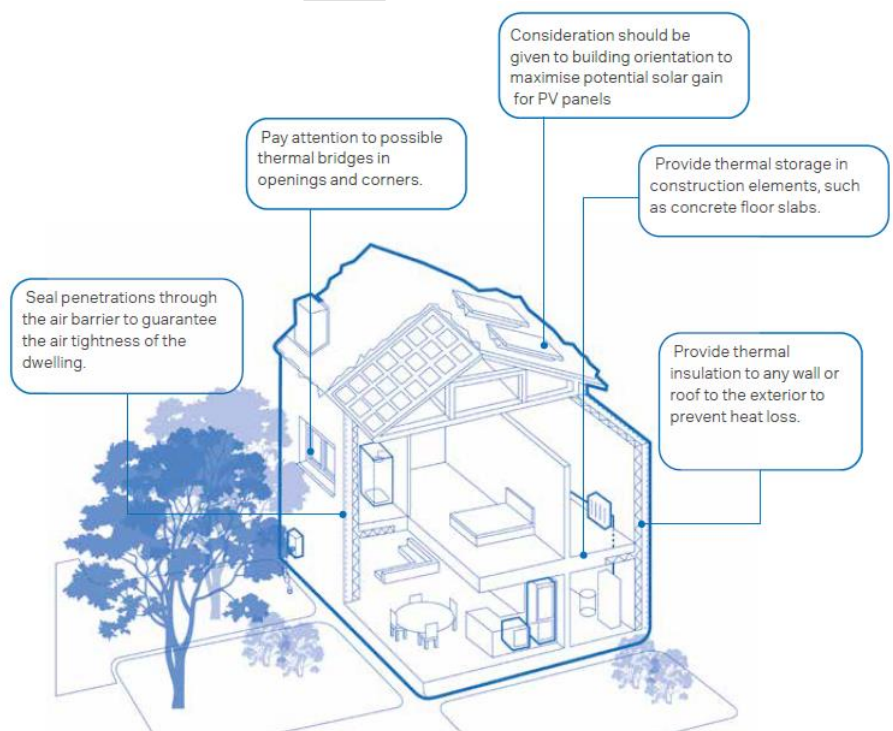

Figure: 17 Diagram illustrating aspects relevant to energy efficient designs

Policy SMNP13. DESIGN PRINCIPLES: MATERIALS AND ARCHITECTURAL DESIGN

As a general rule, the materials and architectural design of buildings should conform to the following principles:

- The use of material and architectural designs should reflect the characteristics and variety found in that character area. In the case of sites on the edge of another character area, the transition with the adjoining area should also be taken into account.
- The environmental properties of materials should be considered (and referenced in the sustainability statement) and may justify the inclusion of materials not currently found in the area provided that it reflects the colour palette of the parish.

¹⁸ Dorset Council - Planning Applications National and Local List of Requirements, October 2022
<https://www.dorsetcouncil.gov.uk/documents/35024/282235/New+Validation+Checklist+-+V1.1+Final+-+1+October+2022.pdf/c281a77c-d6ae-991e-e90e-e535a0f9804a>

- The architectural design should include features to add interest and variety appropriate to the nature and context of the building, and to increase the environmental standards of the building where feasible (the latter should be referenced in the sustainability statement). In particular, consideration should be given to:
 - the use of porches on dwellings (or how the entrance is defined on commercial properties)
 - the use of decorative gables, ridge tiles and chimneys on dwellings
 - the integration of solar panels, and whether these can be part of (rather than added to) the roof
 - the use of roof overhangs and window reveals
 - window size, style, and the use of lintels, sills and decorative shutters on dwellings.

DRAFT

9. HOMES AND BUSINESSES

OBJECTIVES

- Provide opportunities for local people to continue to live in the area by provision of an appropriate mix of housing types within any new development. This should include sufficient numbers of affordable homes for first-time buyers and young families, and housing suitable for older, retired people.
- Encourage employers to provide employment opportunities within the parish for local people.

9.1 HOW MUCH HOUSING IS NEEDED?

9.1.1 There is no set housing or development target for the parish of Sturminster Marshall in the adopted Local Plan from 2014¹⁹. The village of Sturminster Marshall is identified as a rural service centre, and Policy KS2 of the Local Plan says that in such settlements “residential development will be allowed of a scale that reinforces their role as providers of community, leisure and retail facilities to support the village and adjacent communities”. The smaller settlements of Almer and Mapperton on the western edge of the parish, and Henbury and Jubilee Cross to the south, fall within the category of hamlets, “where development would not be allowed unless it was functionally required to be in the rural area”.

9.1.2 The possibility of a more significant level of growth was first raised in July 2018, when East Dorset District Council published their first draft of the East Dorset Local Plan. This proposed a housing target for Sturminster Marshall of at least 250 dwellings for the period up to 2033, noting that this would require the release of land from the Green Belt. However progress on this draft was abandoned following the creation of the unitary authority, Dorset Council, in 2019.

9.1.3 In January 2021 Dorset Council published the first draft of the new Dorset-wide Local Plan²⁰. This included a method for calculating the minimum housing need for Neighbourhood Plan areas. The targets were based on projecting forward the typical additional “windfall” housing that had taken place previously, together with any existing planning consents, and any proposed site allocations. On this basis, Sturminster Marshall’s indicative target was 472 dwellings for the period up to 2038, of which land was allocated for 425 homes on land to be released from the Green Belt, with the remainder expected to come forward through extant consents and windfall development (such as infilling within the village and the conversion / replacement of rural buildings). This level of development was considerably higher than what would have been the ‘pro-rata’ share of the Dorset-wide need, if this was based on the varying size of settlements across the area²¹.

¹⁹ Christchurch and East Dorset Local Plan Part 1 - Core Strategy

²⁰ Draft Dorset Local Plan - Volume 1, page 57 <https://www.dorsetcouncil.gov.uk/documents/35024/285538/DCLP-Jan-2021-DorsetCouncilLocalPlan-vol1.pdf/7e0ff0f0-426f-523d-bd45-cc1fe4d60fac>, and Appendix 2 <https://www.dorsetcouncil.gov.uk/documents/35024/285538/DCLP-Jan-2021-appendices-1-5.pdf/50747301-c2cd-2667-aece-e91248c2bb0d>, retrieved 1 Sept 2021

²¹ Data from the published Local Housing Needs Assessment for the emerging Dorset Local Plan ([Dorset and BCP Local Housing Needs Assessment](#), Icen Projects Limited on behalf of Bournemouth, Christchurch and Poole and Dorset Council, November 2021) uses the household growth figure and factors in an affordability adjustment (Tables 5.2 and 5.3: East Dorset = 325 dwellings per annum, adjusted to 516 with the affordability adjustment). It then considers whether this is excessive compared to the adopted Local Plan strategy, and caps the amount of uplift to 40% in line with Government guidance, giving an overall annual housing target of 455 dwellings (Table 5.4: East Dorset = 455 dwellings per annum). Assuming a pro-rata apportionment based on Sturminster Marshall’s comparative size (using the latest available Census data at that time), would have suggested a target of around 8 to 9 dwellings per annum.

	Dorset LP (draft)	LHNA (2022-based)
Overall target	1,793dpa	458dpa (capped)
Pro-rata (2011 Census households)	SM 747 / D 158,738 = 0.47%	SM 747 / ED 37,319 = 1.99%
Potential target	1,793 x 0.47% = 8.4dpa	458 x 1.99% = 9.1dpa

9.1.4 In January 2022, the Leader of Dorset Council announced that he had been in discussion with Central Government to allow Dorset to pilot a radically different approach to Local Plan making. The timetable for preparing the Local Plan has been extended, and the next draft of the plan is now unlikely to be published before 2024. The targets proposed in 2018 and 2021 were both reliant on releasing land from the Green Belt, which is a decision that can only be made through the Local Plan process. Proposed changes to National Planning Policy suggested in December 2022 look to clarify that authorities are not expected to review the Green Belt if this would be the only way to meet their housing needs in full.²²

9.1.5 A consideration of the available data covering local need arising from within the village, and an assessment of past rates of development as an indicator of what has been possible (as set out in **Appendix 6**), suggests that a housing target of at least 30 dwellings over 10 years (or 3 dwellings per annum) would seem an appropriate basis to plan for as an interim position, with the aim to review this when the Local Plan target for this area, and the decision as to whether sites may be released from the Green Belt, has been confirmed.

9.2 THE TYPE OF HOUSING NEEDED

9.2.1 In terms of housing mix, comments made as part of the early community consultation highlighted concerns over the number of larger homes, which were considered to be less affordable and typically shoe-horned into plots that were too small for them. Published evidence has also highlighted the following key concerns and issues:

- House prices are unaffordable to households on less than average incomes²³, and there are a significant number of households on the affordable housing register. This indicates a clear need for providing affordable housing, for rent and for sale.
- In terms of affordable housing, to support those looking to buy:
 - The level of discount on affordable housing for sale should be set at a minimum of 40%²⁴;
 - Rent to Buy and shared ownership options should be included in order to widen opportunities for homeownership²⁵;
 - House types are likely to be entry-level properties typically with one or two bedrooms, ideally with sufficient space to enable home working.
- In terms of affordable housing to rent, to support those on below average incomes where home ownership is not an option:
 - At least 75% of the affordable housing should be provided for homes in this category to reflect the acute affordability issues present in the neighbourhood area, and include options for social rented homes;

²² <https://www.gov.uk/government/consultations/levelling-up-and-regeneration-bill-reforms-to-national-planning-policy>

²³ Based on the research undertaken in late 2020, the income required to buy an average market home for sale (£84,214) was considerably higher than what would be expected to be available to those on mean household incomes (£49,800). Likewise, the income required to buy an average entry-level home for sale (£78,107) was also higher than what those on mean household incomes can afford.

²⁴ Based on the research undertaken in late 2020, which at that time showed the mean income (£49,800) as being just below the purchasing threshold for Discounted Market Sale at -40% (£50,529).

²⁵ Based on the research undertaken in late 2020, which at that time showed shared ownership at the 25% level having the greatest potential to extend homeownership to those on mean incomes. Rent to Buy was also shown to be a viable route to affordable home ownership to those on mean incomes.

- House types should reflect the current demand indicated by the affordable housing register, but are likely to be for one or two bedroom homes, and may also include options for house-sharing in order to widen opportunities for more affordable rents.
- Open market homes should include a mix of house sizes, broadly in line with the latest modelled recommendations for the Eastern Dorset / Suburban Fringe areas, which suggests approximately 5% as 1 bedroom homes, 30 - 35% as 2 bedroom homes, 40 - 45% as 3 bedroom homes and 15 - 20% as 4+ bedroom homes
 - 1 and 2 bedroom homes should primarily be designed for older households to downsize (such as 1 or 2 bedrooms bungalows and retirement homes built to the optional building regulation standards M4(2) and M4(3));
 - 3 bedroom homes should primarily be designed as small, family homes with gardens;
 - In order to broaden the mix of house types, 4+ bedroom homes should be designed to be adaptable to include the ability to provide annexed accommodation or greater live-work flexibility.

9.2.2 Following the experience of how the Covid 19 pandemic impacted the world, it also makes sense to design for greater flexibility, to accommodate working from home.

9.2.3 The 2014 Local Plan suggests that at least 50% of homes on large greenfield sites should be affordable, dropping to 40% on brownfield sites. More recent published viability information²⁶ suggests that the level of affordable housing provided in the Dorset East area (within which the parish sits) may have to be reduced to 35% in order to be viable across most sites, allowing for higher build standards and costs and with a mix of First Homes, shared ownership and social rent as the affordable tenures. This reinforces the need for the open market mix to include dwellings of a type and size that would inherently be more affordable.

Policy SMNP14. HOUSING TYPES

New housing developments should seek to meet the housing needs priorities of Sturminster Marshall parish, comprising:

- i) affordable rented homes, and particularly social rented options, aimed at those living in or who have a local connection to the parish and who are on below average incomes – where viable this should make up at least 30% of dwellings on larger sites
- ii) intermediate affordable homes such as discounted starter homes and shared ownership options, aimed at those living in or who have a local connection to the parish who are looking to buy but are unable to afford open market prices (the level of discount will need to be set with regard to local wage levels) – where viable these homes make up at least 10% of dwellings on larger sites
- iii) a broad mix of market housing but including homes suitable for older residents looking to down-size, and homes suitable for young families looking to get onto the housing ladder. Larger (4+ bedroom) homes should not exceed 20% of the open housing mix and be designed to be adaptable to include the ability to provide annexed accommodation or greater live-work flexibility.

In order to support home-working, the design of new housing should include clearly identifiable space within the home (or curtilage) that can be used as a designated work area (i.e. not part of the shared living space).

²⁶ <https://www.dorsetcouncil.gov.uk/-/dorset-council-area-viability-assessment> Dorset Local Plan Viability Assessment, May 2022 - report for Dorset Council by Three Dragons

9.3 POTENTIAL HOUSING SITES

9.3.1 Consideration has been given to whether this Neighbourhood Plan could actively allocate sites for housing. The ‘call for sites’ undertaken as part of the work on the Neighbourhood Plan identified many landowners interested in developing sites for housing, but the vast majority of these were in the Green Belt. Those that were not covered by Green Belt restrictions are listed below.

134 High Street Site ID CFS-1 (0.22 ha)	A dwelling and its curtilage, which would require the demolition of some of the existing dwelling and improved access to accommodate further development and would need to retain the public footpath on the northern edge of the site. Development in the very easternmost part of the site is restricted by Green Belt.
Land off Moor Lane, Birchmere Site ID CFS-10 (0.67 ha)	A mix of greenfield and previously developed land within the settlement boundary, currently proposed for employment in the Local Plan. A planning application for outline consent to erect nine live-work units and nine industrial units was submitted in October 2022 (ref P/OUT/2022/05665) covering this area and some of the adjoining land to the south and east.
Bailie Farm Site ID SHLAA 5 (part) (0.23 ha)	A small part of the promoted site, to the south side of the Bailie Farm complex, lies inside of the settlement boundary and is not restricted by Green Belt.

9.3.2 Whilst it could be possible to allocate one or more of the above sites for development in this plan, it is clear that, on their own, they would not meet the housing needs for the area. The two smaller sites would be supported in principle under existing Local Plan policies, as they lie within the settlement boundary, but are unlikely to be of sufficient size to viably support any affordable housing. The Birchmere site would depend on whether the strategic need for employment land is outweighed by housing (Dorset Council’s Economic Needs Assessment has not yet been published as of May 2023). There are also access issues that would need to be addressed in all cases to ensure that pedestrian safety is not compromised. On this basis, these sites are not included as specific allocations at this time.

GREEN BELT RESTRICTIONS

9.3.3 Whilst the South East Dorset Green Belt precludes general housing development, it does allow

- **limited infilling in villages** - this could apply if the defined village boundary does not accord with the real extent of a village on the ground, and the infill site was physically located within the village on this basis;
- **the re-use of buildings** – but only if the buildings are of permanent and substantial construction and their development would preserve the openness of the Green Belt and would not conflict with the purposes of including land within it;
- **the partial or complete redevelopment of previously developed land** – but only if the development would not have a greater impact on the openness of the Green Belt than the existing development; or not cause substantial harm to the openness of the Green Belt and would meet an identified affordable housing need. The definition of previously developed land explicitly excludes land that is or was last occupied by agricultural or forestry buildings; land that has been developed for minerals extraction or landfill and which is to be restored, land in built-up areas such as residential gardens, and land that was previously developed but where the remains of the permanent structure or fixed surface structure have blended into the landscape;
- **limited affordable housing for local community needs** – but only if this accords with the development plan policies for rural exception sites. In the case of the East Dorset Plan (policy LN4) this would restrict any such development to land adjoining or very close to the village of Sturminster Marshall, and would not apply to the outlying hamlets.

OPPORTUNITIES FOR MORE AFFORDABLE HOUSING

9.3.4 Whilst it may be unlikely that any of the landowners with sites adjoining Sturminster Marshall would wish to pursue an affordable housing option (as those promoting larger sites are likely to wait and see if Green Belt land will be released through the Local Plan), the Neighbourhood Plan can extend the potential for rural exception sites to include locations such as Jubilee Cross, that are reasonably well served by public transport and have been assessed as having potentially suitable land for housing development (subject to Green Belt restrictions). Allowing for some open market housing (up to 25%) on such sites may also improve viability and the chances of more affordable housing overall being built locally.

Policy SMNP15. RURAL EXCEPTION SITES FOR AFFORDABLE HOUSING

Rural exception sites within the Green Belt adjoining the village of Sturminster Marshall and within the built-up area at Jubilee Cross will be supported, provided:

- The proposed development would provide a mix of affordable housing size and type which meets demonstrated local housing needs arising from within the parish, and taking into account the need for car ownership for locations that are poorly served by public transport;
- Any open market housing must be demonstrably necessary to facilitate the affordable housing, be of a type and size to reflect local need, and should only comprise a small proportion (no more than 25%) of the total housing mix on that site;
- Secure arrangements are included to ensure that affordable housing will be enjoyed by successive as well as initial occupiers, with priority given to those with a local connection to the parish;
- The development would not significantly detract from the character of the settlement and the surrounding landscape.

9.4 EMPLOYMENT AND BUSINESS OPPORTUNITIES

9.4.1 Historically the main occupations of Sturminster Marshall parish residents have been centred on farming, but by the 21st century less than 4% of the population had become involved with agriculture, forestry and fishing²⁷. With the transition to larger highly mechanised arable farms, there are only two dairy farms in the parish. Local employment opportunities in the Parish are now based on the Bailie Gate Industrial Estate, Henbury Farm Industrial Estate and local shops (the two convenience stores and the farm shop in Henbury) and other community facilities such as the school and public houses.

9.4.2 In recent years the Parish has become more of a dormitory area with an aging population, and the findings from our 2020 Household Survey and latest Census data reflect this, with very few working people in employment in the parish (although a large percentage were working from home) and over 30% retired. Few parishioners work at the Bailie Gate Industrial Estate - most of those employed there travel into the village from elsewhere²⁸.

9.4.3 A business survey was conducted during October 2020 but unfortunately only seven companies responded, possibly due to them generally having no or very little connection to the village or parish.

²⁷ based on 2001 and 2011 Census outputs for this area <https://www.nomisweb.co.uk/query/advanced.aspx> – 2021 industry dataset not yet available at OA level

²⁸ A point noted in the 2004 village plan and which continues to hold true

Figure 18: Bailie Gate Industrial Estate



9.4.4 Bailie Gate Industrial Estate is identified as employment land in the Local Plan (Policy PC1), which specifies that a flexible approach will be adopted allowing a diverse range of employment uses. Land is allocated through the Policy RA1 of the adopted Local Plan (and currently proposed in the emerging Dorset Council Local Plan) to extend the Bailie Gate Industrial Estate to provide further employment in Sturminster Marshall.

Figure 19: Bailie Gate Industrial Estate extension

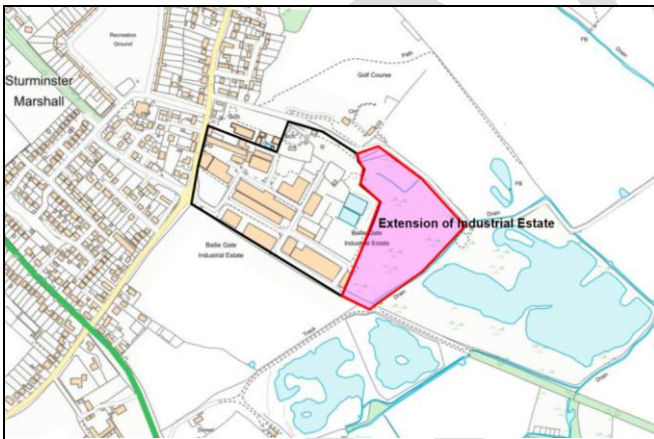

The Local Plan recognises the need for a planned approach to this development in this location, including the need for significant landscape buffers alongside the countryside edges of the site, appropriate drainage and a travel plan to reduce the amount of commuting. Local residents have raised strong concerns regarding the impact of increased traffic (including HGVs) along Station Road and, should further development take place to the south, it would make sense to explore the option to provide an alternative access to the Industrial Estate, that would provide relief to those living on or using Station Road. The policy also refers to Use Classes B1, B2 and B8, and the first of these (B1) now falls within the broader Class E that includes other uses typically found on a High Street, such as shops, cafes and restaurants as well as medical and fitness premises. Given that the industrial estate is reasonably central to the village, typical 'High Street uses would serve the local population, but would best be located fronting the High Street, rather than to the rear of the industrial estate. Permitted development rights have also been introduced that would potentially allow some employment falling within Class E (commercial, business and service) to change to residential use (subject to certain conditions) which

USE CLASSES

The Town and Country Planning (Use Classes) Order defines different land uses, within which a change of use is not taken to be development (and therefore do not require planning permission), unless such changes have been explicitly ruled out through the imposition of a planning condition. The main use classes involving employment are:

- E (Commercial, Business and Service)
- B2 (General Industry)
- B8 (Warehousing and Distribution).

would not be appropriate in the main employment areas of the parish if we are to retain opportunities for people to work close to home.

9.4.5 The units at Henbury Farm Industrial Estate and Field Dairy Farm provide alternative options for businesses seeking to locate in the area, ensuring that there is a degree of competition that should ensure business rentals remain at a more affordable rate.

Map 11. Employment Areas

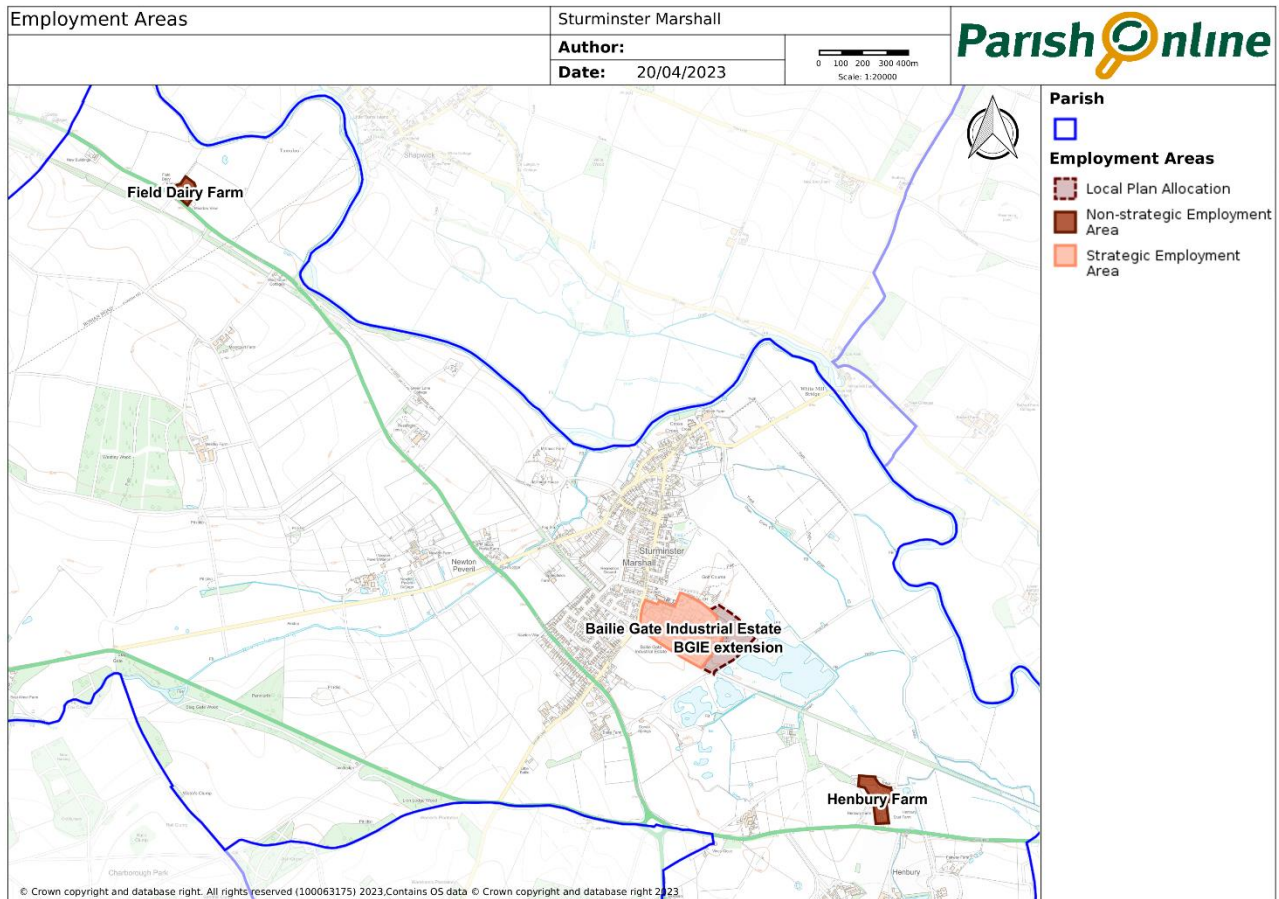

9.4.6 Our research did not identify a clear need for additional employment premises over and above that already allocated. Very few local residents (only 2 of the more than 300 responses from the household survey) stated a potential need for business premises, and both would be of a scale that could be accommodated within the existing (and proposed extension to) employment areas.

9.4.7 The following policy looks to refresh these employment policies, taking into account all of these factors and the work undertaken on design and accessibility through this Neighbourhood Plan.

Policy SMNP16. SUPPORTING LOCAL EMPLOYMENT OPPORTUNITIES

The retention and small-scale expansion of existing employment sites allowed through the Local Plan will apply to sites shown on Map 11, subject to Green Belt restrictions.

Within the Baillie Gate Industrial Estate, Use Class E, B2 and B8 employment uses are supported, but typical 'High Street' uses (Use Class E (a – f)) should be located on land fronting onto the High Street and be of a scale appropriate to Sturminster Marshall village as a rural service centre, with B2 and B8 or otherwise unneighbourly employment uses located away from this frontage.

The expansion of the Baillie Gate Industrial Estate, as envisaged in Policy RA1 of the Local Plan and identified in Fig. 18, should:

- Be limited to Use Class E(g) (Office, Research and Light Industry), B2 (General Industry) and B8 (Warehousing and Distribution) employment uses (through the imposition of appropriate conditions);
- Incorporate significant landscape buffers on the north, west and southern boundaries abutting the countryside;
- Be accompanied by a Flood Risk Assessment in accordance with Policy SMNP2;
- Be in accordance with design Policies SMNP9-12
- Provide for safe and attractive pedestrian and cycle links in accordance with Policy SMNP19;
- Be accompanied by a Transport Assessment in accordance with Policy SMNP20;
- Improve traffic management including, if feasible, the delivery of a new link road connecting onto the A350 in accordance with Policy SMNP21.

Employment premises should be designed to be adaptable, with the arrangement of doors, windows and parking provision, and the relationship between units, designed to enable future sub-division into smaller units (and combining into larger units) without the need to re-build. Explanation of flexibility in the design should be included within the sustainability statement.

DRAFT

10. COMMUNITY FACILITIES

OBJECTIVES

- Protect and enhance the range of community facilities in the Parish including retail, sport, play, education, and social infrastructure

10.1 EXISTING COMMUNITY FACILITIES

10.1.1 Sturminster Marshall village may not have a village centre or high street typical of other Dorset villages, but nonetheless there are a range of community facilities in the Parish, including shops, pubs, halls, a school and pre-school, churches, a park and recreation ground. Our household survey confirmed that local people value these facilities.

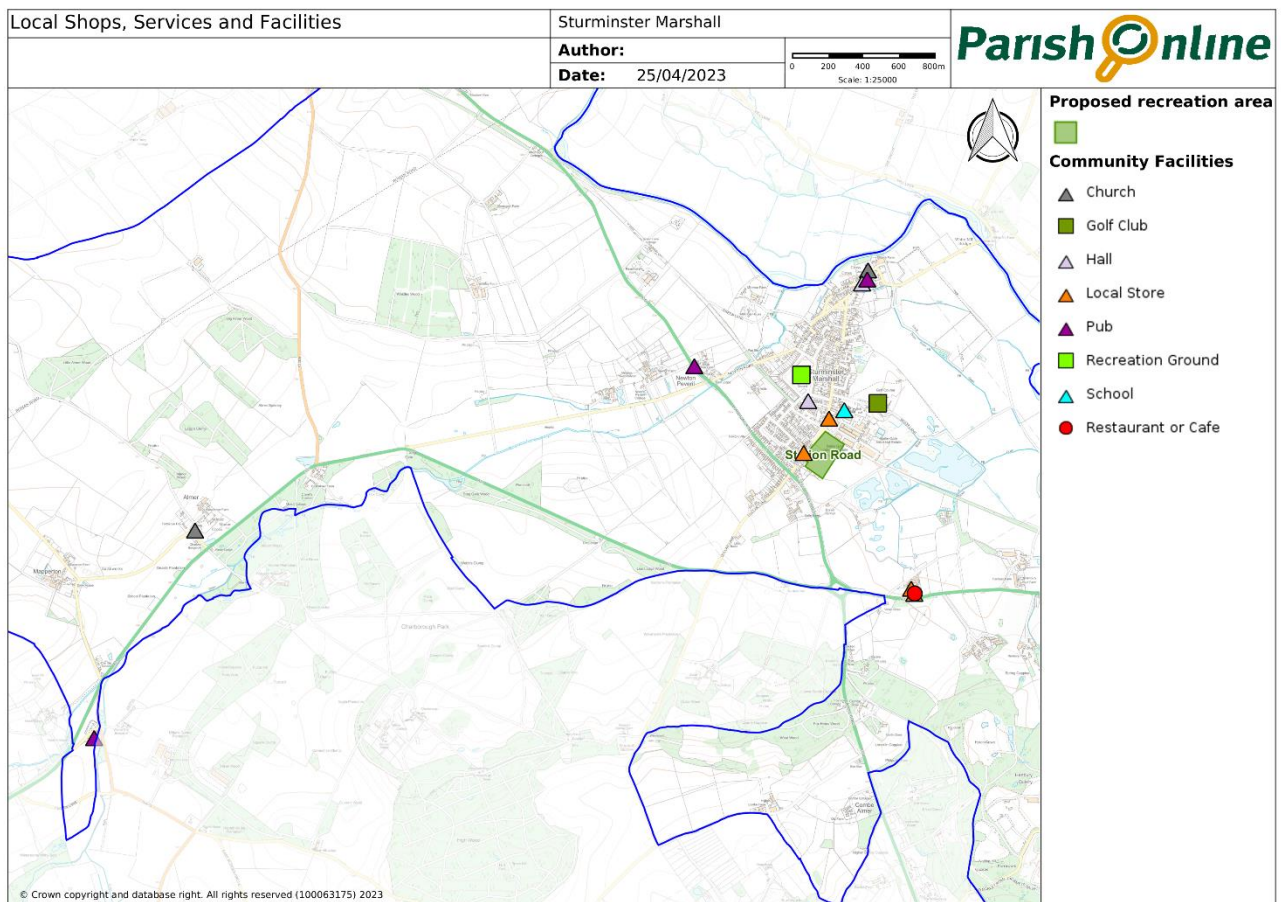

Map 12. Community Facilities – Sturminster Marshall Village

SHOPS AND RETAIL

10.1.2 There are two shops within the village of Sturminster Marshall: the Spar on Station Road, and the NISA store (which contains the village Post Office and Pharmacy) on the High Street. These two stores provide local choice for basic food / convenience goods, and access to banking and healthcare (prescriptions service). There is also a farm shop at Vines Close (on the A31) with a butchers and café, motor mechanics garages at Henbury, Bailie Gate Industrial Estate and Jubilee Cross, and a retail warehouse on Dullar Lane.

SOCIAL AND SPIRITUAL

10.1.3 The Memorial Hall opened in 1992 and provides a central hub for many village activities. There are built-in Sport changing rooms, 2 halls (total capacity 460 people), a large Kitchen, a committee room and a lounge bar. The Hall is used for;

- Badminton
- Bowls
- Kick boxing
- Arts reach - plays and musical performances
- Brownies, Guides
- Craft club
- Yoga
- New Life Bible Church
- Short Tennis
- Tea and toddlers
- Parish Council meetings
- Private parties and celebrations.



10.1.4 The Old School is run by Mackrell Charity and is a social lifelong learning Hub. The facility has capacity for 100 people and also offers scholarships for children and young adults aged to 11- 19 years. The Hall is used for lectures, Art and Bridge Classes, Judo, Gardening Club, Senior Lunch Club, Cream Teas and the Church uses it for social gatherings.

10.1.5 St Marys Church, Sturminster Marshall holds Church Services every week and monthly concerts. There is a small congregation for the population of village settlement. St Marys Church, Almer is a 13th Century Church holds services once a month and is used as a meeting place.

10.1.6 There are 3 public houses in the Parish. The Red Lion and The Golden Fox are located in the village and used by many local residents. The Worlds End is located in Almer. Sturminster Marshall Golf Club also offers a bar and eating area.

10.1.7 The public green spaces are also important for social events. These spaces are covered in the section on Local Green Spaces, but as an example, there is a Maypole located on Maypole Green, where May Day Celebrations have taken place since 1101 and the school children take part in the maypole dancing.



OUTDOOR SPORT AND RECREATION

10.1.8 Churchill Close Recreation Ground is the main sports facility for the village and is owned by the Parish Council. This also includes a play area with swings, slide, climbing frame and rope swing. The recreation ground is well used by the thriving village Football Club. The Football Club use the changing facilities in the Memorial Hall for their games. The area is identified and protected as a Local Green Space in Section 7.4.

10.1.9 Sturminster Marshall Golf Club is a popular 9 hole course on Moor Lane. This facility has been designated as an Asset of Community Value.



EDUCATION

10.1.10 Sturminster Marshall Pre-School has successfully run from a purpose-built building within the main school grounds. It caters for children aged 1 to 4 years. Sturminster Marshall First School is a one-form entry school (for 4-9 years) with a capacity for 150 children. It needs improvement including a new school hall and toilets.

10.1.11 Older children can be bussed to the catchment middle and upper schools at Corfe Mullen (Lockyers and Corfe Hills). Some local children are educated at alternative schools in the wider area.

HEALTHCARE

10.1.12 Up until 2018 a Doctors Surgery was held once a week within the Memorial Hall. This service was withdrawn as the facilities in the Hall were not fit for purpose. The Wellbeing Pharmacy is located within the NISA store on Station Road. This offers a consulting room for services such as flu injections and blood pressure checks.

10.2 FUTURE NEEDS

10.2.1 Consultation with local residents has told us how important local facilities are in the Parish. The responses showed that the community highly value the local shops, pharmacy, footpath and bridleways, school and preschool, park, Memorial Hall and Churchill Close recreation ground and the Old School Hall. When asked what their top priorities for improvements or new facilities, residents' feedback was more footpath and bridleways, a new health centre, allotments, more open spaces for sports and leisure, a skate park and an all weather pitch. Other responses included the need for youth facilities and tennis courts. Further consultation with the local community showed a continued support for a health care facility, hard surface pitch (for tennis/netball) and a central shopping area.

10.2.2 A number of residents suggested creating a central shopping area and this is something that will be considered in the next review of the Neighbourhood Plan, when it is clearer the level of development that may come forward through the Local Plan.

10.2.3 Saved policy SM3 allocates land at Station Road for public open space for sports pitches, and it would be possible to accommodate a small building containing changing rooms and pavilion together with car parking in this location.

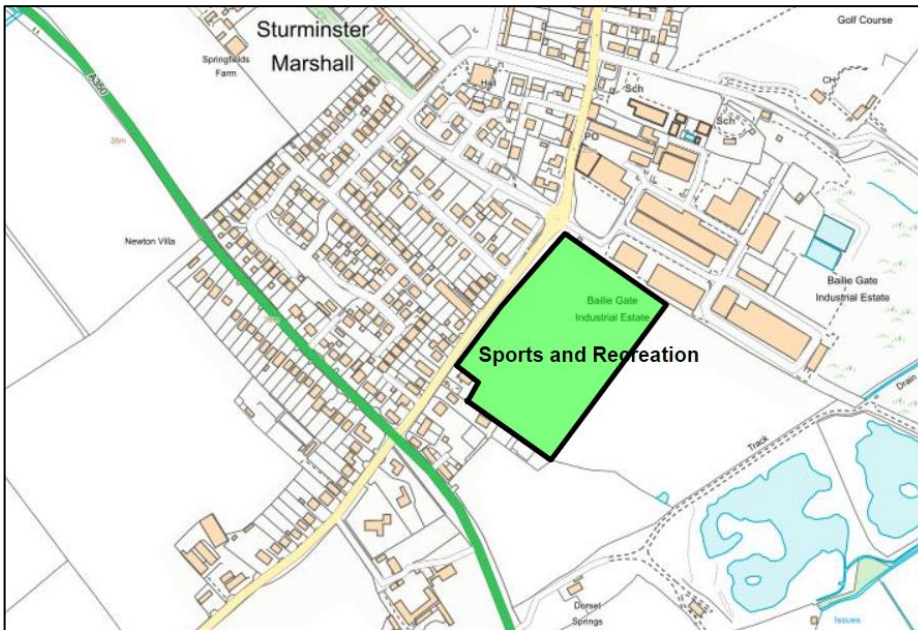

Figure 20: Proposed additional Sports and Recreation land.

Whilst the landowner is now promoting this site for residential use through the Dorset Local Plan, the need for sports pitches is still relevant, together with a need for allotments, skate park and a multi use games area. Furthermore, due to the proximity to Dorset Heathlands, any major housing development sites will need to provide Suitable Alternative Natural Green Space in order to mitigate potential harm to the sensitive heathland sites (Dorset Council provides further guidance on this in the Dorset Heathlands Planning Framework²⁹).

10.2.4 The Church have indicated that the graveyard may need expanding in about 15 years when it is anticipated to be at capacity, and therefore this is a matter which should be kept under review.

10.2.5 Consultation with the First School has highlighted the need for improvements such as a new school hall and toilets. The aspiration for a new health care facility has been discussed, but does not appear possible due to the limited population of the village (nor with the level of growth envisaged in the draft Dorset Local Plan - discussions with the NHS have revealed that a new Medical Centre can only be justified if it will serve over 10,000 patients). If the new Local Plan does include proposals for a significant level of growth in the area, the impact on local services such as education and healthcare provision will need to be assessed at that time. However, should developers look to bring forward large-scale development in advance of decisions on the Local Plan, the impact on school and health care services, and how any shortfalls can be addressed, must be considered.

Policy SMNP17. SUPPORTING AND IMPROVING COMMUNITY FACILITIES

Development proposals to improve the provision of community facilities in a manner in keeping with the character of the area will be supported. Every effort should be made to work with the local community and relevant authorities to investigate potential solutions to avoid any loss of these valued assets:

- Sturminster Marshall First School with associated Pre-school provision
- Spar and NISA stores with associated Post Office and Pharmacy services
- Memorial Hall and Old School

²⁹ Dorset Heathlands Planning Framework 2020 - 2025 Supplementary Planning Document, April 2020
<https://www.dorsetcouncil.gov.uk/planning-buildings-land/planning-policy/supplementary-planning-documents-and-guidance/all-of-dorset/dorset-heathlands-planning-framework>

- St Mary's Church (Sturminster Marshall) and St Mary's Church (Almer)
- The Red Lion, The Golden Fox, The Worlds End and the bar / catering facilities at Sturminster Marshall Golf Club.
- Churchill Close Recreation Ground and Sturminster Marshall Golf Club

Policy SMNP18. SPORTS AND RECREATION AREA – LAND AT STATION ROAD

Land at Station Road, as identified in Saved Policy SM3 and shown in Fig. 19, is reserved for public open space for the sport and recreation needs of the community, which may include:

- sports pitches
- allotments
- a Multi Use Games Area
- a skate park
- a small building containing changing rooms and pavilion
- car parking to serve the sports and recreation area.

Policy SMNP19. INFRASTRUCTURE NEEDS OF LARGE SCALE DEVELOPMENT

Large scale development should demonstrate that the Parish Council, education and healthcare services providers have been actively involved in assessing the infrastructure needs to accompany such development, and a comprehensive package to deliver anticipated community infrastructure needs should be included as part of the development proposals.

11. TRAFFIC, TRANSPORT, WALKING & CYCLING

OBJECTIVES

- Reduce problems associated with street parking, especially close to the school and retail outlets.
- Explore ways in which traffic movements may be modified to avoid congestion, in particular, along Station Road and sections of High Street.
- Identify where opportunities may arise to create safe routes for walkers, cyclists and horse riders.

11.1 RIGHTS OF WAY, WALKING & CYCLING

WALKING

11.1.1 There are many public rights of way in the Parish of Sturminster Marshall which are used regularly by residents and visitors including: public footpaths; bridleways, unclassified roads and permissive paths. This includes two long distance paths:

- **The Hardy Way** – which runs through the parish on highways via Dullar Lane, Station Road, High Street, Church Street and Mill Lane.
- **The Wareham Forest Way** – which runs from Dullar Lane in Lytchett Matravers Parish, through Higher Combe Farm across A350 along footpath E53/4 through Henbury Park then across the A31, to use footpath E53/1 connecting to the High Street. The crossing points of the A31 and A350 require walking on those roads for short sections.

11.1.2 A table and map showing all the current footpaths and bridleways in the parish, together with permissive paths and the unclassified routes that are more suited to walkers, is included in **Appendix 7**.

11.1.3 The Stour Valley Way runs along the Shapwick side of the river (including a section of permissive path) and on to Kingston Lacy and Pamphill; but is not directly accessible from Sturminster Marshall. The inclusion of a footbridge would allow walkers to walk to Shapwick or Wimborne or access the paths on the Kingston Lacy Estate. Whilst a bridge would be a major investment it would bring many connectively benefits and proposals are being discussed with promoters of the Stour Valley Park.

CYCLING

11.1.4 As at 2023, Dorset Council's map of advisory cycle routes across the county does not include any routes (on or off road) in the parish. The national cycle network route N25 runs to the north of the parish, connecting Wimborne to Blandford along comparatively quiet rural lanes. It is legal to cycle on bridleways, although many routes are not suited for easy access and would require a mountain bike to use.

11.1.5 **Dullar Lane / Station Road to White Mill** is a very popular route for cyclists, connecting south to Lytchett Matravers (and then back into the parish at Jubilee Cross), and north to the national cycle route.

11.1.6 The **D40707** at Mapperton is another locally known and popular recreational cycle route that connects to bridleways north to Spetisbury and Charlton Marshall.

NORTH DORSET TRAILWAY

11.1.7 The aspiration to transform the disused railway into a recreational route linking the towns that were on this historic route has been a long-standing ambition, and was included in the 2002 East Dorset Local Plan. The enhancement and protection of the trailways to provide off road walking and cycling links between suburban and rural areas is included in the Core Strategy (Policy KS9), and the route of the railway marked on the policies map.

Local Transport Plan 3, April 2011

“A key opportunity is in developing and managing Trailway routes, utilising old disused railway lines, for shared use by walkers, cyclists and horse riders. These routes offer great potential to provide enhanced countryside access and to celebrate Dorset’s natural, cultural and industrial heritage. By their very nature, they link settlements, possess gentle gradients which facilitate accessibility and longer distance suburban / rural cycle commuting, and provide off road cross-country routes.”

para 8.5.2

11.1.8 The Corfe Mullen cycle path currently stops abruptly on the south side of the A31, just short of the parish boundary. To the north, the section to Blandford is provided as far as Spetisbury. It is understood that the North Dorset Trailway Network group (NDTN) is working closely with Dorset Council to improve and extend the Trailway, including the section through the parish.

11.1.9 Within Sturminster Marshall parish, only a small section of the disused track is currently accessible (footpath E53/20). The ramp at Newton Road is also too steep for disability access or for an inexperienced

cyclist. Part of the track has been built on within the Bailie Gate Industrial Park, but it would still be possible to provide a link directly to the south side of the estate. There are no gradients, buildings or agricultural uses on the trackbed between the industrial estate and the A31 that would prevent this section of the westward route from being opened up. Solutions to safely cross the A350 to the north of the village will need further consideration.

SOLUTIONS TO BE EXPLORED

11.1.10 Walking or cycling, rather than using a motor vehicle, particularly for short journeys, helps reduce congestion, vehicle emissions and promotes health and well-being. Feedback from our consultations highlighted a need for more ‘joined up’ walking routes (including circular routes for recreational walks), the problems with having to walk alongside or cross the A31 and A350, and frustration at the poor condition of many of the routes.

11.1.11 It is clearly important to safeguard walking and cycling routes so that these remain attractive options for people to use. In particular, routes into the village centre to shops, the school and community and leisure facilities are paramount. Residents in Jubilee Cross have also highlighted the importance of access to the facilities in Lytchett Matravers for their needs. Wherever possible these should be accessible for people with mobility difficulties – and this would also allow their use by young families using pushchairs / strollers.

11.1.12 As part of these consultations, the following improvements to the rights of way were strongly supported. These are shown on Map 13, and it is hoped that these can be included in the next iteration of the Dorset Council Rights of Way Improvement Plan.

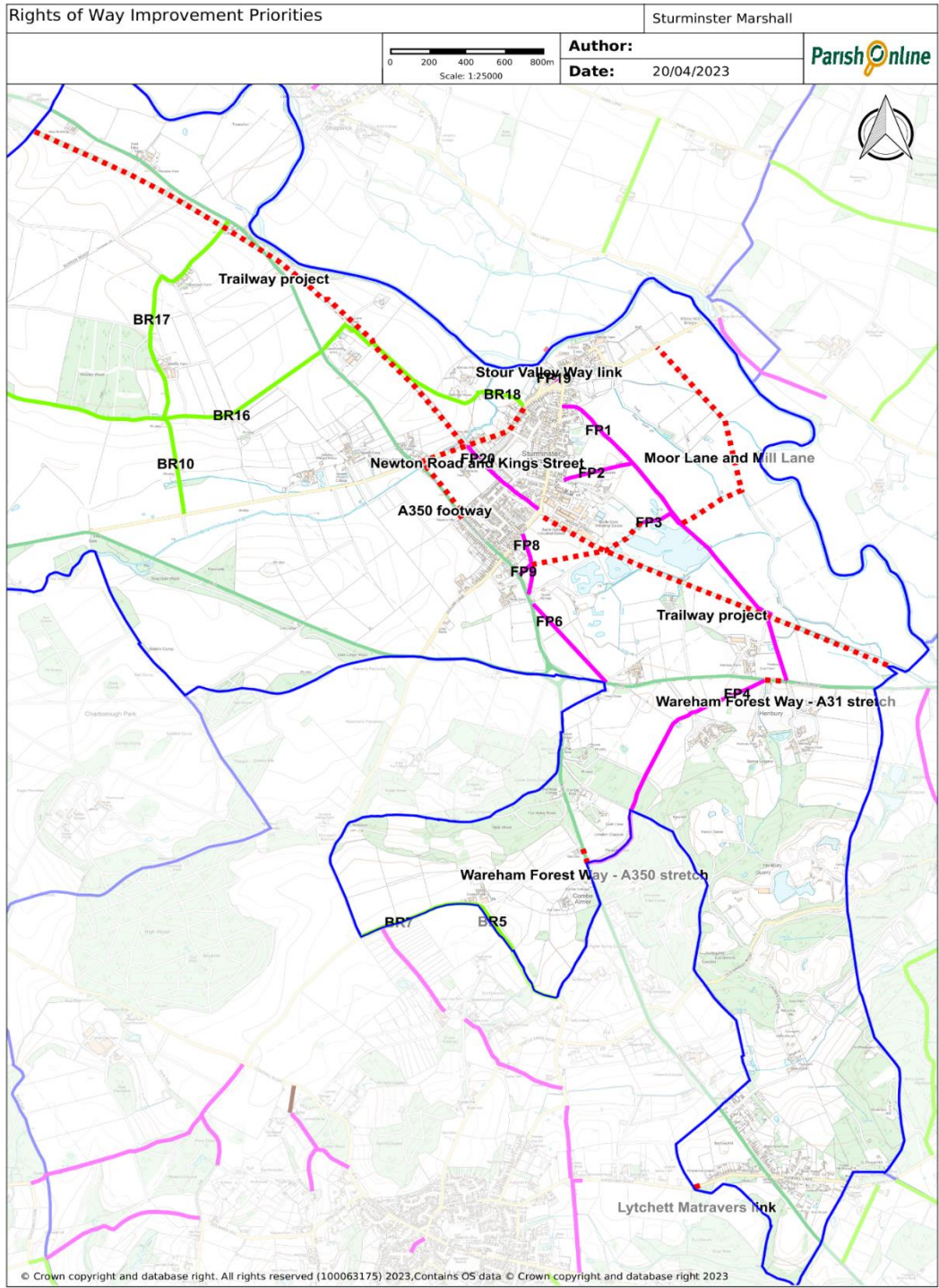

- Parish
- Public Rights of Way
 - Bridleway
 - Footpath
- PRoW Improvements

Map 13. Rights Of Way Improvements.

Table 11. Rights of Way Improvement Priorities

Trailway project	Extending the Trailway through Sturminster Marshall to enable onward links to Spetisbury and Corfe Mullen, including improvements to the access (ramp) on footpath E/20 from Newton Road to cater for those with disabilities and including a bridle way / cycle path next to the south side of the Bailie Gate Industrial Estate (where development has already taken place on the track bed).
Stour Valley Way link	Providing a footbridge over the river at Walnut Tree Field to allow direct access to the Stour Valley Way
Jubilee Cross to Lytchett Matravers link	Extending the footway from Jubilee Cross to enable onward link along Wimborne Road to Lytchett Matravers (the pavement currently stops at the last house in Jubilee Cross)
Moor Lane and Mill Lane	Promoting Moor Lane to Mill Lane path as a circular recreational route primarily for walkers, and improving the safety of Mill Lane for walkers and cyclists, which would also enable better access to trails north of the River Stour.
A350 in Sturminster Marshall village	Extending the footway alongside A350 to Junction of Newton Road at Maggs Bridge
Henbury to Sturminster Marshall link	Improving pedestrian links from Henbury to Sturminster Marshall village. A footpath from Henbury to Vines Close linking to footpath E53/6 would help Henbury residents access shops and bus services in Sturminster Marshall, but this might also be achieved via footpath E53/1 and the Trailway, providing a safe crossing of the A31 can be achieved.
Newton Road and Kings Street	Improving the safety of Newton Road and Kings Street for walkers and cyclists, or providing a separate footway along these routes if feasible.
Wareham Forest Way crossing points	Improving the safety of those sections of the Wareham Forest Way that require walking on the A31 and A350.

Policy SMNP20. RIGHTS OF WAY, WALKING AND CYCLING

Development should not result in an adverse impact on the safety of users of the key pedestrian and cycle route network shown on Map XXX. Any development that would adjoin or incorporate these routes should seek to improve their safety and amenity, and retain and where possible enhance their rural character, so that more people are encouraged to walk and cycle.

The delivery of the improvements identified in Table 11 will be supported. Where development includes any part of proposed new routes, including the Trailway extension, these routes should be safeguarded and measures taken to link into them from the development where appropriate.

New development should be planned to be permeable, promoting active travel at all times, and where practical, include options for onward walking and cycling connections

Pedestrian / cycle routes should be designed to be attractive, safe and convenient, and meet the following standards:

- routes should be reasonably direct, with good surveillance, avoiding sharp turns and confined corridors (e.g. not in between high fences or walls with no surveillance)
- the design should reflect the rural character of the area, be of sufficient width to allow users to pass easily and safely, and where possible allow wheelchair and pushchair access and use, with surfaces designed to be well-drained and low maintenance
- where appropriate the routes should be landscaped to create attractive 'green corridors' with use of grass, shrubs and other appropriate planting and boundary treatments, that will provide added wildlife benefit.

11.2 ROAD TRAFFIC AND HIGHWAY SAFETY

11.2.1 The Parish of Sturminster Marshall is situated at the intersection of two major roads (A350 and A31) that experience high traffic volumes at peak times. It has been acknowledged for some time that the north-south routes within Dorset itself are no longer suitable for the volume and types of modern vehicles travelling on them. The local authorities at one time were planning to construct a bypass for Sturminster Marshall, Spetisbury and Charlton Marshall (following which the existing road connecting the villages would be downgraded and appropriate environmental and safety measures introduced to manage the traffic)³⁰, but this never achieved high enough priority for inclusion in the regional or national funding allocations. A study of the A350 has been promised for some years and was due to be published in Spring 2023³¹. It is clearly important that the cumulative impact of development along this corridor is considered, to help with understanding the capacity and safety issues, and identifying what improvements are needed going forward. This is a strategic matter outside the scope of this Neighbourhood Plan.

11.2.2 The main access routes into the village of Sturminster Marshall are directly off the A350, either using Station Road or Newton Road. The location of the Bailie Gate Industrial Estate in the village means that Station Road has a much higher level of medium and heavy goods vehicles, as well as agricultural machinery. The village roads and Mill Lane, towards White Mill Bridge and the B3082 (Blandford/Wimborne Road), are also used as a “rat run” during peak traffic periods due to drivers trying to avoid delays on the A350 and A31. Due to the haphazard nature of on-street parking, some areas such as near the shops and school and in older parts of the village where homes were built without parking and limited pavements, can also be problematic.

The impact of traffic problems associated with the A350 were debated in Parliament (Westminster) in 2003, when Robert Walter (MP for North Dorset) said

“There are overpowering traffic, economic, social and environmental reasons to invest in a new and improved road rather than in the existing A350 road. Let us therefore consider the case for a solution and the current state of the proposals. The case is clear: the volume, weight and speed of motor vehicles in the villages in the A350-B3081-C13 corridor between Shaftesbury and Sturminster Marshall are dangerous and damaging hazards to people and the environment”

Policy SMNP21. TRANSPORT ASSESSMENTS

Transport assessments, where required, should demonstrate:

- how the development will alter the size and volume of the vehicles accessing the site;
- how the adequacy of the routes (in terms of their functional width given on-street parking levels within the village) has been taken into account in assessing safety and traffic flows;
- how likely growth in traffic (including the cumulative impact of development planned on the A350 corridor up to and including Blandford Forum and proposed expansion of the Bailie Gate Industrial Estate) has been taken into account;
- how findings arising from the A350 study have been taken into account.

11.2.3 Concerns raised by local residents as part of the surveys and consultations for the Neighbourhood Plan (and previously through the parish plans) focussed on:

- difficulties for vehicles accessing the A350 via Station Road and Newton Road safely, mainly due to volume of traffic, causing frustration and queues at peak periods,

³⁰ As reflected in the 2002 East Dorset Local Plan, Chapter 16. The bypass was not carried forward in the core strategy following the dismissal of the Westbury bypass scheme in 2009, where it was confirmed that the route was non-strategic and that the landscape and other harms outweighed the need

³¹ As referenced in and the latest Department of Transport report, “Road Investment Strategy 2: 2020–2025” which includes a new study relating to the A350 within the M4 to Dorset Coast connection review.

- parking causing congestion / safety concerns in the High Street and Station Road, exacerbated by the number of lorries, buses and queuing at peak periods,
- traffic speeds, particularly within the village and on minor roads where the highway is shared with pedestrians and cyclists, further exacerbated through commuters looking to avoid the A350

It was also acknowledged that the above concerns are likely to increase with the cumulative impact of housing building in the area.

The Parish Council will continue to raise highway safety issues relating to the A350 and A31 with Dorset Council on behalf of its parishioners, and seek solutions for improving access to the A350 (or creation of a new road from Bailie Gate Industrial Estate to the A350) before any further development occurs.

SOLUTIONS TO BE EXPLORED

A NEW ROAD LINK ONTO THE A350

11.2.4 Whilst highway improvements are largely a strategic matter, the possible development of land off Station Road between the Industrial Estate and the A350, alongside the proposed expansion of the Bailie Gate Industrial Estate, provides an opportunity to explore the feasibility of creating another access point to the A350. Such an access could be more suited to cater for the lorries / HGVs that need to get to and from the industrial estate, and potentially reduce the amount of traffic queuing at the Station Road A350 junction. Whilst there are clearly cost implications of providing a new road, it does have the potential to address the existing issues which would otherwise be exacerbated by further development.

TRAFFIC MANAGEMENT IN THE VILLAGE

11.2.5 Whilst opportunities to increase off-street parking provision will be encouraged, such improvements will depend on sites coming forward for development. The County parking standards³² generally requires at least 1 parking space (plus visitor spaces) for 1 and 2 bedroom homes, and at least 2 parking spaces (plus visitor spaces) for larger, family homes, with additional provision for visitors or where parking is provided in garages (as these tend to get used for storage). The latest (2021) Census data shows the average car ownership level in the parish to be in excess of 1.8 cars per household, with 23% of households having 3 or more cars³³, indicating that at least 2 spaces plus visitor parking should be sought in most circumstances.

11.2.6 The design of parking should not result in development that is unsightly or in which parked motor vehicles will dominate the street scene. In general, and particularly for larger family homes, cars should be placed at the side of the property, so that the parked car (or garage if used), does not project forward in front of the building line. If parking provision is made at the front of a property, the appropriate boundary treatments and street trees should be included in the design, as well as variation in surfacing / paving materials. On-street parking should be provided in clearly marked areas using changes in paving materials. For small pockets of housing, a rear court may be an appropriate solution, provided that this is readily accessible (and therefore likely to be used instead of on-street parking). Parking clusters (of no more than 4 spaces in any one group) should be interspersed with trees and soft landscaping to provide shade and visual interest. Good practice guidance on setback and on-street parking provision is provided in Figure 21, and should be favoured where applicable to the area's character.



³² Residential Car Parking Provision – Local Guidance for Dorset, May 2011 <https://www.dorsetcouncil.gov.uk/planning-buildings-land/planning/transport-development-management/car-and-cycle-parking-standards>

³³ Table TS045 <https://www.nomisweb.co.uk/query/select/getdatasetbytheme.asp?opt=3&theme=&subgrp=>

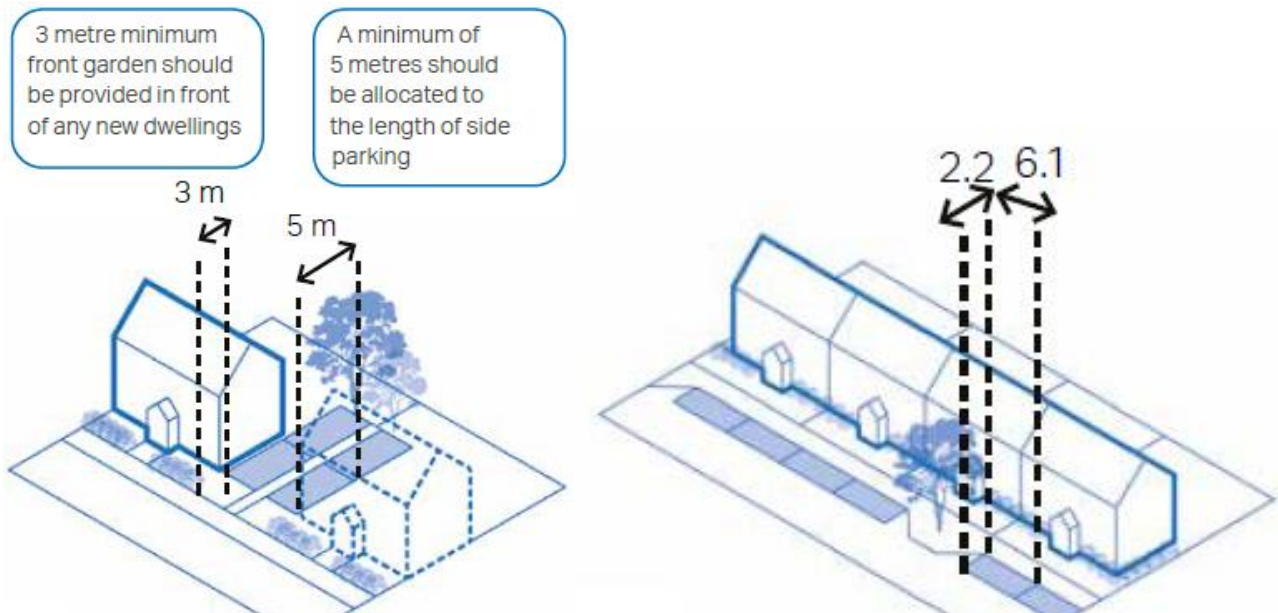

Figure 21: On-plot parking best practice guidance

11.2.7 Better signage, enhanced speed restrictions and traffic calming measures can also be pursued, subject to sufficient funding and agree with Dorset Highways. The objective of the traffic calming will be to introduce a safer environment for pedestrians and road users by reducing the average speed of traffic within the village to 20mph. Extending the footways and reducing traffic speeds is also needed for the built up areas along the A350, so that residents in Dullar Lane, along the main road and at Newton Peveril can more easily access the village on foot, and to improve safety for all road users (particularly those turning in and out of the village). This should ideally include extending the pavement northwards along the A350 up to and including the junction with Newton Road, and extending the 30mph speed limit to cover the whole section of the A350 from just south of the entrance to Dorset Springs to the far side of The Golden Fox. The use of speed indicator devices along this section would assist in the effectiveness of these measures.

The Parish Council will seek to work with Dorset Council Highways to identify and implement better signage, enhanced speed restrictions and traffic calming measures.

IMPROVED PUBLIC TRANSPORT PROVISION

11.2.8 Whilst not linked directly to development, public transport improvements are needed if we are serious about providing a realistic alternative to car use. In particular, improving the frequency and increasing the coverage of bus services to enable travel to key local centres such as Wimborne, Poole and Blandford, would be welcomed.

Policy SMNP22. TRAFFIC MANAGEMENT AND TRANSPORT IMPROVEMENTS

Traffic management proposals will be supported, particularly where these will help achieve the following objectives:

- the reduction of traffic congestion / queuing for vehicles accessing onto the A350 from the village
- improvements to the pedestrian and cycle route network, including the (missing) link along the A350 between Station Road and Newton Road;
- the alleviation of problems associated with on-street parking pressures;
- the reduction of traffic speeds, including measures such as implementing 20mph traffic speed restrictions or calming measures within the village, and the extension and reinforcement (through speed indicator devices or other measures) of the existing 30mph limit on the A350.

Large scale development within or to the south side the Bailie Gate Industrial Estate up to the A350 must consider the feasibility of providing a new link road connecting onto the A350, and safeguard such a route if practical and deliver it if it is viable to do so.

Policy SMNP23. PARKING STANDARDS

Development should be designed to meet or exceed the number of car parking spaces set out in the adopted car parking standards, taking into account the latest data on car ownership levels. Unallocated on-street parking as part of this provision will only be supported where there are safe crossing points and traffic flows would not be impeded.

The design of parking should not result in development that is unsightly or in which parked motor vehicles will dominate the street scene. Garages should be at least 6m x 3m to provide sufficient room for cars to park inside them as well as providing some room for storage.

Opportunities must be created for unallocated electric vehicle charging points for visitors and residents, designed to integrate without detriment to the public and private realm.

DRAFT

12. POLICIES LIST

Policy SMNP1.	SUSTAINABLE DEVELOPMENT STANDARDS
Policy SMNP2.	CONTROL OF FLOODING
Policy SMNP3.	SEWAGE TREATMENT WORKS
Policy SMNP4.	MAINTAINING LOCAL CHARACTER
Policy SMNP5.	VALUED VIEWS
Policy SMNP6.	LOCAL GREEN SPACES
Policy SMNP7.	PROTECTING AND ENHANCING OUR LOCAL WILDLIFE AND HABITATS
Policy SMNP8.	UNDESIGNATED HERITAGE ASSETS AND OTHER LOCALLY IMPORTANT BUILDINGS
Policy SMNP9.	KEY DESIGN PRINCIPLES
Policy SMNP10.	DESIGN PRINCIPLES: LAYOUT
Policy SMNP11.	DESIGN PRINCIPLES: BUILDING FORM AND SCALE
Policy SMNP12.	DESIGN PRINCIPLES: BOUNDARY TREATMENT AND PUBLIC REALM
Policy SMNP13.	DESIGN PRINCIPLES: MATERIALS AND ARCHITECTURAL DESIGN
Policy SMNP14.	HOUSING TYPES
Policy SMNP15.	RURAL EXCEPTION SITES FOR AFFORDABLE HOUSING
Policy SMNP16.	SUPPORTING LOCAL EMPLOYMENT OPPORTUNITIES
Policy SMNP17.	SUPPORTING AND IMPROVING COMMUNITY FACILITIES
Policy SMNP18.	SPORTS AND RECREATION AREA – LAND AT STATION ROAD
Policy SMNP19.	INFRASTRUCTURE NEEDS OF LARGE SCALE DEVELOPMENT
Policy SMNP20.	RIGHTS OF WAY: WALKING AND CYCLING
Policy SMNP21.	TRANSPORT ASSESSMENTS
Policy SMNP22.	TRAFFIC MANAGEMENT AND TRANSPORT IMPROVEMENTS
Policy SMNP23.	PARKING STANDARDS

13. APPENDIX 1– ADOPTED LOCAL PLAN – KEY POLICIES

Policy KS2 Settlement Hierarchy	Sets out the broad location, scale and distribution of development in the wider area. The village of Sturminster Marshall is classed as a Rural Service Centre. These settlements are described as the “Main providers for the rural areas where residential development will be allowed of a scale that reinforces their role as providers of community, leisure and retail facilities to support the village and adjacent communities”. This in effect classes it as one of the larger rural settlements in East Dorset, with no strategic housing allocations, but with the ability to identify rural exception sites (under Policy LN4), new services and facilities (under Policy LN7) and potentially some economic development (under Policy PC4). The village envelope comes from saved policy A1, which enables housing infill within that area.
Policy HE1 Valuing and Conserving our Historic Environment	Outlines that heritage assets will be conserved and where appropriate enhanced for their historic significance and importance locally or the wider social, cultural and economic environment.
Policy HE2 Design of New Development	Requires that the design of development is of a high quality, reflecting and enhancing areas of recognised local distinctiveness. The policy specifically references the guidance provided in the Countryside Design Summary as relevant for this area.
Policy HE3 Landscape Quality	States that proposals will need to demonstrate that various factors have been taken into account, including: the character of settlements and their landscape settings; natural features such as trees, hedgerows and wildlife corridors; important views; tranquillity and lack of light pollution.
Policy LN1 The Size and Type of New Dwellings	States that new market and affordable dwellings will be expected to reflect the needs of the Strategic Housing Market Assessment, subject to site specific circumstances and the character of the local area.
Policy LN2 Design, Layout and Density of New Housing Development	States that the design and layout of new housing development should maximise the density of development to a level which is acceptable for the locality. A minimum density of net 30dph will be encouraged, unless this would conflict with the local character and distinctiveness of an area where a lower density is more appropriate.
Policy LN3 Provision of Affordable	Seeks to maximise affordable housing provision, whilst ensuring flexibility and sufficient margins to facilitate housing delivery. Sites with 4 or fewer dwellings may opt for a financial contribution (the NPPF post-dates this and suggests such contributions should no longer be required), with on-site provision on larger sites at a rate of 50% for greenfield sites (40% for brownfield sites), with this proportion generally split as 70% rented to 30% intermediate affordable housing tenures. On sites resulting in a net increase of 5 to 14 dwellings, the Councils will require on site affordable housing provision in accordance with the Policy Percentage Requirements and Affordable Housing Requirements, however, where this is not possible or at the Councils’ discretion, a financial contribution in lieu of on site affordable housing will be acceptable, calculated in accordance with the Commuted Sum Methodology
Policy LN4 Affordable Housing Exception Sites	Seeks to enable the provision of affordable housing in areas where no significant development is proposed, land adjoining or very close to Sturminster Marshall which would otherwise be considered inappropriate for development.
Policy LN7 Community Facilities and Services	Seeks to provide new facilities and services to support existing and future population growth and changes in the age profile in Sturminster Marshall

Policy PC1 Employment Land Hierarchy	Identifies that Bailie Gate Industrial Estate will also be a focus for meeting projected requirements for B1 (Office and Light Industrial uses), B2 (General Industry) and B8 (Warehousing and Distribution) uses.
Policy PC4 The Rural Economy	Encourages economic development in or on the edge of existing settlements where employment, housing, services and other facilities can be provided close together, provided the development is small scale to reflect the rural character. The conversion and re-use of buildings and the development and diversification of agricultural and other land-based rural businesses may also be supported.
Policy PC5 Shops and Community Facilities in Local Centres and Villages	Seeks improvements to the provision of shops which provide for people's day to day needs, leisure uses including public houses and facilities for local communities will be supported in principle. The loss of existing retail premises, leisure and other local facilities will be resisted.
Policy RA1 Strategic Allocations in the East Dorset Rural Areas	States that 3.3 hectares of land at Bailie Gate, Sturminster Marshall should be removed from the Green Belt and allocated for new employment to meet the future needs of businesses throughout East Dorset, but particularly the rural areas of East and North Dorset.

Saved policies SHDEV 6 and SHDEV 8 the East Dorset Local Plan 2002 allow appropriate small scale shopping facilities and protect from proposals that would result in the loss of shops, public houses or community facilities. Saved policy SM3 allocates land at Station Road, Sturminster Marshall for public open space for sports pitches.

14. APPENDIX 2 – LIST OF SUPPORTING EVIDENCE

Housing Needs Assessment

Site Options and Assessment document

Local Green Spaces Report

Strategic Environmental Assessment

Habitats Regulations Assessment

Design Codes

Household Surveys

DRAFT

STURMINSTER MARSHALL NEIGHBOURHOOD PLAN

LOCAL GREEN SPACES REPORT



JUNE 2021

Contents

Local Green Spaces	3
Policy Background	3
Selection and Assessment	3
Individual Site Assessments	5
LGS1: Bartons Ground	5
LGS2: Charborough Green	11
LGS3: Churchill Close	14
LGS4: Commons within the Conservation Area	18
LGS5: The Old Railway Line	23
LGS6: Walnut Tree Field	28

Appendix 1: Responses to Household Questionnaire

Appendix 2: Sample letter to Landowners

Local Green Spaces

Policy background

The designation of Local Green Spaces is governed by guidance in paragraphs 99 & 100 of the 2019 National Planning Framework

99. The designation of land as Local Green Space through local and neighbourhood plans allows communities to identify and protect green areas of particular importance to them. Designating land as Local Green Space should be consistent with the local planning of sustainable development and complement investment in sufficient homes, jobs and other essential services. Local Green Spaces should only be designated when a plan is prepared or updated, and be capable of enduring beyond the end of the plan period.
100. The Local Green Space designation should only be used where the green space is:
1. a) in reasonably close proximity to the community it serves;
 2. b) demonstrably special to a local community and holds a particular local significance, for example because of its beauty, historic significance, recreational value (including as a playing field), tranquillity or richness of its wildlife; and
 3. c) local in character and is not an extensive tract of land.

Within Sturminster Marshall Parish, a number of sites has been suggested (all within Sturminster Marshall village) as potentially qualifying for Local Green Space status and designation of these sites is thought to be consistent with the objectives set out in paragraph 99 of the National Planning Framework.

Selection and Assessment

The sites detailed in this report have been selected based on the results of the initial consultation event and the household survey. Of the sites given high scores by people in the parish one, the Golf Course, was rejected because, although highly rated as a valued area for recreation and potential wildlife value, it does not qualify as it is defined as an extensive tract of land under the criteria set out in paragraph 100c of the National Planning Framework guidance notes.

Assessment was made using the framework set out in the guidance documents and based on a number of criteria.

Local Green Spaces within the parish fall into two main groups

1. Sites used for active recreation. Charborough Green and Churchill Close fall within this category.
2. Sites valued for their cultural value and used for more informal recreation. Maypole Green, Stocks Green, Timber Green and Trafalgar Green fall within this group.
3. Sites of wildlife value which are also used for informal recreation. This group comprises Bartons Ground, The Old Railway Line and Walnut Tree Field, although the last of these also has significant archaeological value, as a Scheduled Ancient Monument.

Where plant species lists are given, these are based on casual observations by the members of the Environment Working Group of the Sturminster Marshall Neighbourhood Plan Steering Group rather than systematic sampling of the communities present. Nomenclature in these lists follows **Bowen, H. (2000): *The Flora of Dorset***. Pisces Publications, Newbury.

Local Green Spaces

Sturminster Marshall

Author: L. Administrator

Date: 07/06/2023

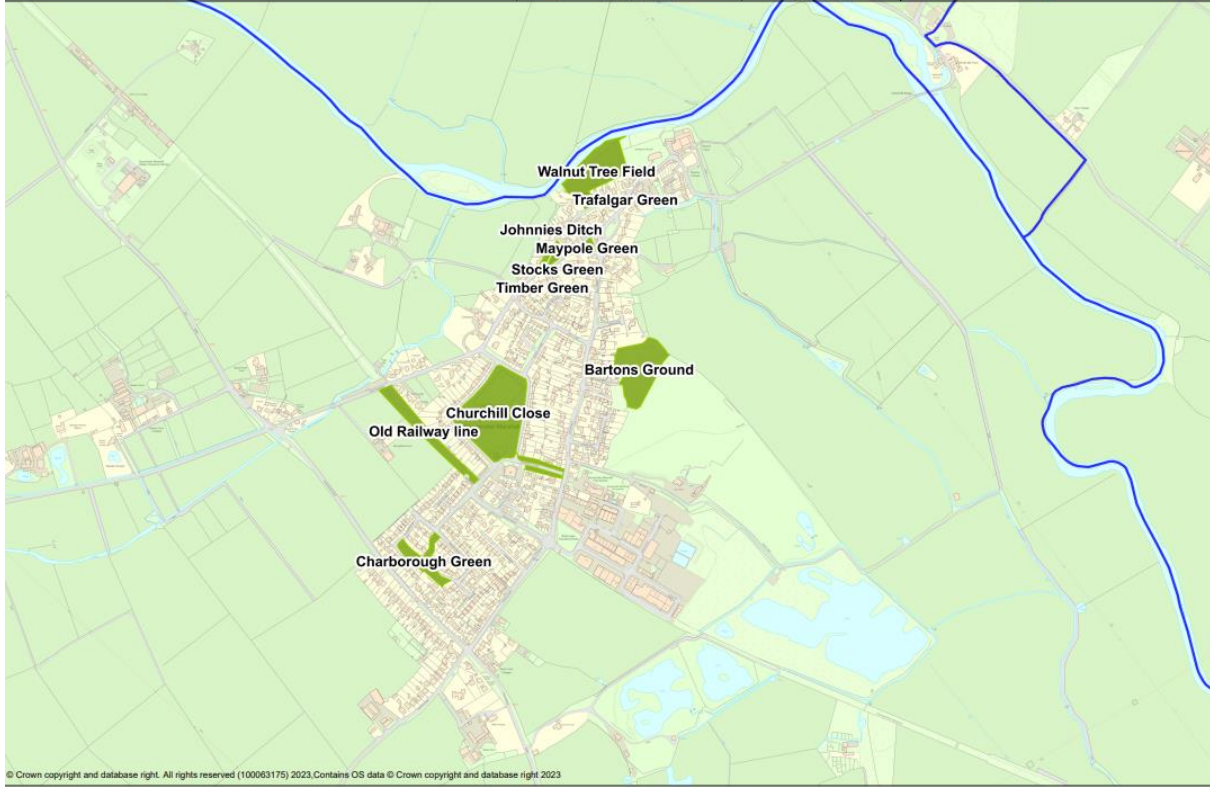

© Crown copyright and database right. All rights reserved (100063175) 2023. Contains OS data © Crown copyright and database right 2023

Individual Site Assessments

LGS1: Bartons Ground

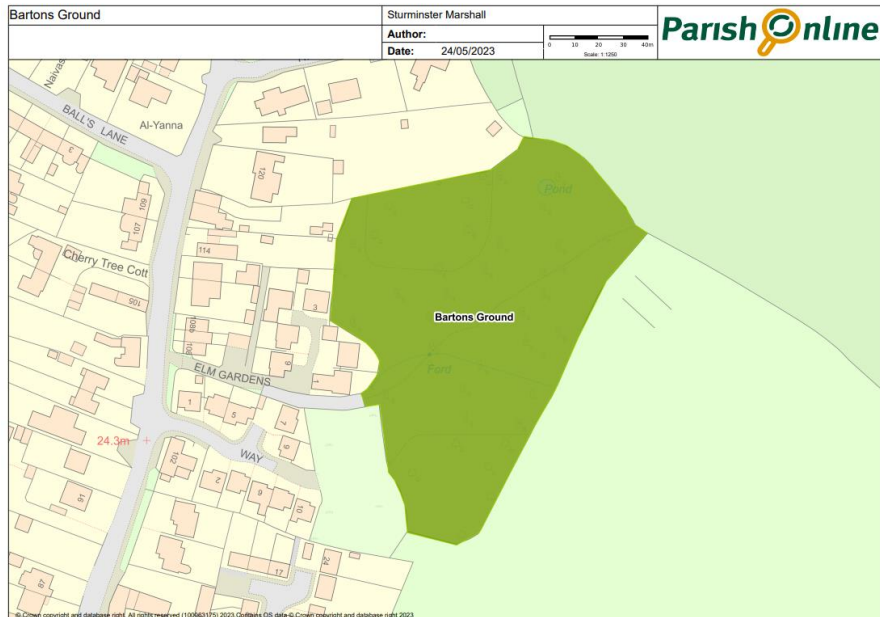

Bartons Ground is owned by Eton College but has been leased to the Sturminster Marshall Parish Council since 2000, at a peppercorn rent, as a community asset. The initial 20-year lease was renewed in 2020 for a further period of 5 years, subject to annual review allowing the college to terminate the lease early should they so desire. Under the terms of the lease, the Parish Council has been responsible for maintenance and management of the site and it planted the two groups of trees early during the initial lease period. The lease has now been terminated by Eton College.

Bartons Ground is an area which, until about 30 years ago, was grazed by sheep. The main vegetation type is MG1 as defined below. Within the site are three other features: a temporary pond in which standing water is present when winter ground water levels are high and the two areas of woodland planted by the Parish Council. A permissive footpath crosses the site.

This site is used as open space, primarily by walkers and dog walkers and has connections to a wider footpath network, in particular, the adjacent Wareham Forest Way. It is part of the historic flood meadow system and was formerly grazed, primarily by sheep. The combination of grassland, woodland and an ephemeral pond, whilst not of especially high wildlife value, does provide a measure of diversity not found in adjacent built-up parts of the village or the short-term grasslands of nearby agricultural fields. In combination with the neighbouring golf course, it also forms part of a more extensive wildlife corridor extending to Henbury Farm. Its ownership by Eton College provides an additional strand to the connections between the village and Eton: the living of St Mary's Sturminster Marshall was, for many years, in the gift of the college, meaning that it had control over the appointment of vicars and a number of them were actually former 'beaks' of Eton.

In a household survey carried out in 2020 by the Neighbourhood Plan Steering Group, a significant number of respondents valued Bartons Ground as a valuable open space. Of the areas of semi-natural (as opposed to sown grassland used for more formal recreation) it was second in importance only to the Walnut Tree Field, which is also an area of MG1 grassland adjacent to the River Stour.

Meeting the criteria

Bartons Ground is immediately behind houses in High Street and is connected to the latter by a footpath, so it fulfils the criterion of being reasonably close

The site is special because it provides both an enhanced diversity of wildlife between housing and relatively species-poor agricultural grassland. It is a tranquil location used extensively for quiet recreational activities.

Whilst the site has no great historical value, other than its connection to Eton College, and no dramatic scenery, it is still a location with a quiet beauty with the combination of grassland, trees and shrubs.

As part of what was once more extensive areas of mesotrophic grassland in the Stour Valley, and, especially with the temporary pond and ditches, it represents the character of a village that has been said to be built on natural springs.

The above features qualify Bartons Ground to be a Local Green Space.

Characterisation

National Vegetation Classification Community MG1 *Arrhenatherum elatius* grassland.

Arrhenatherum elatius grassland is a widespread community in which coarse-leaved tussock grasses, notably *A. elatius* with usually smaller amounts of *Dactylis glomerata* and *Holcus lanatus*, are always conspicuous and generally dominant. Large umbellifers are frequent throughout and sometimes abundant, and the sequential flowering of first *Anthriscus sylvestris* and later *Heracleum sphondylium* is highly distinctive. Tall-herbs are generally infrequent, though a variety of species may attain dominance locally.

Above all, this is ungrazed grassland. It is characteristic of circum-neutral soils throughout the British lowlands and occurs on road verges, railway embankments, in churchyards and neglected agricultural sites, such as pastures and meadows. Without regular mowing, stands are eventually invaded by scrub.

The temporary pond has a distinctive vegetation, dominated by *Carex hirta* (Hairy Sedge). whilst the woodland areas contain a mixture of tree species in which Ash (*Fraxinus excelsior*) is the most common. Locally Bramble (*Rubus fruticosus* agg.) or Stinging Nettle (*Urtica dioica*) form patches of limited size but, overall, the site is dominated by *Arrhenatherum elatius* (False Oat-grass) with *Dactylis glomerata* (Cock's-foot) and *Alopecurus pratensis* (Meadow Foxtail) being the most abundant of the associated species. The most abundant tall herb is *Anthriscus sylvestris* (Cow Parsley), which assumes co-dominance in spring.

Other species in the grassland (whilst this is not a systematic compilation, it is the result of a large number of walks across the area in the spring and summer of 2020)

<i>Conopodium majus</i>	Pignut
<i>Ranunculus repens</i>	Creeping Buttercup
<i>Lolium perenne</i>	Rye-grass
<i>Poa trivialis</i>	Rough Meadow-grass
<i>Poa annua</i>	Annual Meadow-grass
<i>Poa pratensis</i>	Meadow-grass
<i>Holcus lanatus</i>	Yorkshire Fog

<i>Convolvulus arvensis</i>	Field Bindweed
<i>Cirsium arvense</i>	Creeping Thistle
<i>Barbarea vulgaris</i>	Winter-cress
<i>Lamium album</i>	White Dead-nettle
<i>Glechoma hederacea</i>	Ground Ivy
<i>Heracleum sphondylium</i>	Hogweed
<i>Sonchus oleracea</i>	Sow-thistle
<i>Stellaria graminea</i>	Lesser Stitchwort
<i>Geranium dissectum</i>	Cut-leaved Cranes-bill
<i>Rumex acetosa</i>	Common Sorrel
<i>Rumex obtusifolius</i>	Broad-leaved Dock

Temporary pond species

<i>Carex hirta</i> (dominant)	Hairy Sedge
<i>Glyceria fluitans</i>	Floating Sweet-grass
<i>Potentilla anserina</i>	Silverweed
<i>Juncus effusus</i>	Soft Rush
<i>Sonchus asper</i>	Prickly Sow-thistle
<i>Rumex crispus</i>	Curled Dock
<i>Cardamine pratensis</i>	Cuckoo-flower

Close to the backs of houses in High Street is a patch of suckering Elm (*Ulmus glabra*) trees which fail to reach maturity because of Dutch elm disease, and Horse Chestnut (*Aesculus hippocastaneum*).

Close to this is one patch of planted trees in which *Fraxinus excelsior* (Ash) is most abundant but with some *Quercus petraea* (Sessile Oak), *Betula pendula* (Silver Birch), *Prunus avium* (wild cherry) and *Sorbus aucuparia* (Rowan). The other planted woodland adjacent to the golf course is of *Fraxinus excelsior* with some *Quercus robur* (Pedunculate Oak) and a sparse understorey of *Corylus avellana* (Hazel).

A short stretch of ditch across the central part of the site has *Prunus spinosa* (Blackthorn) and a single bush of *Crataegus monogyna* (Hawthorn)

Individual trees of *Aesculus hippocastaneum* (Horse Chestnut), *Quercus robur* and *Q. petraea*, a Cherry and a single Japanese Maple are also present, whilst the hedgerow separating the site from the golf course is composed of a mixture of

Fraxinus excelsior

Corylus avellana

Acer campestre (Field Maple)

Populus tremula (Aspen), which is also suckering into Bartons Ground close to the kissing gate leading to the Gladwish plots.

Aesculus hippocastaneum

Ulmus glabra

Sambucus nigra (Elder)

Insects seen on Bartons Ground include a number of the more common butterfly species such as Brimstone (*Gonepteryx rhamni*), Small Tortoiseshell (*Aglais urticae*), Gatekeeper (*Pyronia tithonus*), Meadow Brown (*Maniola jurtina*) Small White (*Pieris rapae*), Large White (*Pieris brassicae*), Peacock (*Inachis io*) and Red Admiral (*Vanessa atalanta*), as well as the Poplar Hawkmoth (*Laothoe populi*), which is associated with the Aspen clump.

As well as a range of “garden” birds such as Blackbird (*Turdus merula*), Song Thrush (*Turdus philomelos*), Collared Dove (*Streptopelia decaocto*), Wood Pigeon (*Columba palumbus*), Robin (*Erithacus rubecula*), Dunnock (*Prunella modularis*) Rook (*Corvus frugilegus*), Goldfinch (*Carduelis carduelis*) and Great Tit (*Parus major*), Buzzard (*Buteo buteo*) and Kestrel (*Falco tinnunculus*) have been seen on Bartons Ground, suggesting that small mammals, such as field mice or voles, may also be present.

Vertebrates, other than birds, seen on or close to Bartons Ground include: Sika deer (*Cervus nippon*), Fox (*Vulpes vulpes*), Hedgehog (*Erinaceus europaeus*), Grey Squirrel (*Sciurus carolinensis*), Common Shrew (*Sorex araneus*), Short-tailed Field Vole (*Microtus agrestis*) and Slow worm (*Anguis fragilis*)

Name of Local Green Space	Bartons Ground	
Location / Grid reference	SY950998	
Size (in hectares)	1.245	
Settlement to which it relates	Sturminster Marshall village	<input type="checkbox"/> within <input type="checkbox"/> immediately adjoining Y <input type="checkbox"/> outside (specify distance)
Reason site identified for review	Quiet open space with semi-natural vegetation used for casual recreation	
Accessibility	<input type="checkbox"/> public open space <input type="checkbox"/> footpaths / bridleways	<input type="checkbox"/> commonland / permissive <input type="checkbox"/> clear views into site
Current use and general description	Used as open space, primarily by walkers and dog walkers with connections to a wider footpath network.	
Qualities	High / Med / Low	Notes / Explanation
Landscape quality / importance (eg in key view from a public area)	L	
Historic or cultural significance	L	The living of St Mary's Sturminster Marshall was, for many years, in the gift of Eton College: their ownership of this parcel of land is further evidence of the historic link between the College and the Parish
Recreational value (can include places valued for their tranquillity)	M	A quiet area close to the centre of the village providing ease of access and connections to wider footpath network
Wildlife value	M	The combination of grassland, woodland and an ephemeral pond provide a measure of diversity. In combination with the

		adjacent golf course, it also forms part of a more extensive wildlife corridor extending to Henbury Farm.
Any existing development consents?	Yes / No	No
Landowner details (if known) and any feedback (once contacted)	Owned by Eton College	
Public interest (if evidenced eg local 'friends' group)	The household questionnaire identified this site as one of high value to the community	



Bartons Ground



Temporary pond on Bartons Ground

LGS2: Charborough Green

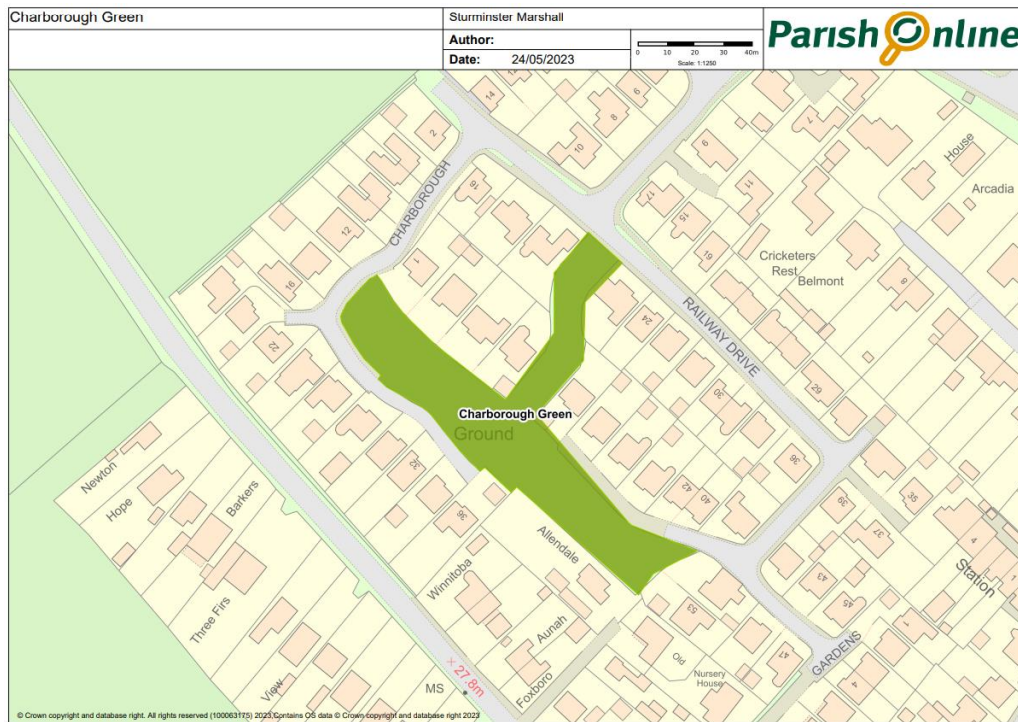

Charborough Green is an open area bounded by Railway Drive and Charborough Way within a modern housing development.

The area is used for casual recreation, especially by children (a junior goal is present on the site) and has been used for social fund-raising events. It is used overwhelmingly by those who live close by, rather than the community as a whole. It does, however, serve as a green break between the adjacent housing.

Meeting the criteria

Charborough Green is within the settlement, being an open space contained by surrounding housing development.

The site has little landscape value and no historical connections.

However, it is a location of significant recreational value, especially in providing a safe space for children to engage in play and informal games. It also provides an amenity for residents in the immediate vicinity.

Although of lesser importance than some of the other suggested areas in the parish, Charborough Green, nevertheless, is a valued open space used extensively by those in surrounding houses.

On recreational grounds, Charborough Green meets the requirements for designation as a Local Green Space.

Characterisation

The site is an area of, mainly, *Lolium perenne* (Rye-grass) recreational turf, with scattered trees of Ash (*Fraxinus excelsior*), Field Maple (*Acer campestre*), and Cherry (*Prunus* sp.) with a containing hedge of domesticated species.

Name of Local Green Space	Charborough Green	
Location / Grid reference	SY94589944	
Size (in hectares)	0.39	
Settlement to which it relates	Sturminster Marshall village	<input type="checkbox"/> within Yes <input type="checkbox"/> immediately adjoining <input type="checkbox"/> outside (specify distance)
Reason site identified for review	Informal recreation area within dense housing development	
Accessibility	<input type="checkbox"/> public open space Y <input type="checkbox"/> footpaths / bridleways	<input type="checkbox"/> commonland / permissive <input type="checkbox"/> clear views into site
Current use and general description	The area is used for casual recreation, especially by children (a junior goal is present on the site) and has been used for social fund-raising events. It consists of an area of mown <i>Lolium perenne</i> (ryegrass) with scattered trees (flowering cherries and field maple) and a containing hedge.	
Qualities	High / Med / Low	Notes / Explanation
Landscape quality / importance (eg in key view from a public area)	L	The site is embedded within a modern housing estate
Historic or cultural significance	L	The site has no inherent features of historic or cultural interest
Recreational value (can include places valued for their tranquillity)	M	The area is used for informal games by people in the immediate vicinity and has

		been the site of fetes organised by local organisations.
Wildlife value	L	As an area of mown grass with a few scattered trees, the wildlife value of the site is low, though it does provide some variety with the urbanised locality.
Any existing development consents?	No	
Landowner details (if known) and any feedback (once contacted)	Dorset Council	
Public interest (if evidenced eg local 'friends' group)	Household survey identified the area as being of value, especially to local residents.	
Other notes eg links to footpath network, boundary definition etc,	In the context of the extensive modern development, this provides a "green lung" and an area used by neighbouring households.	

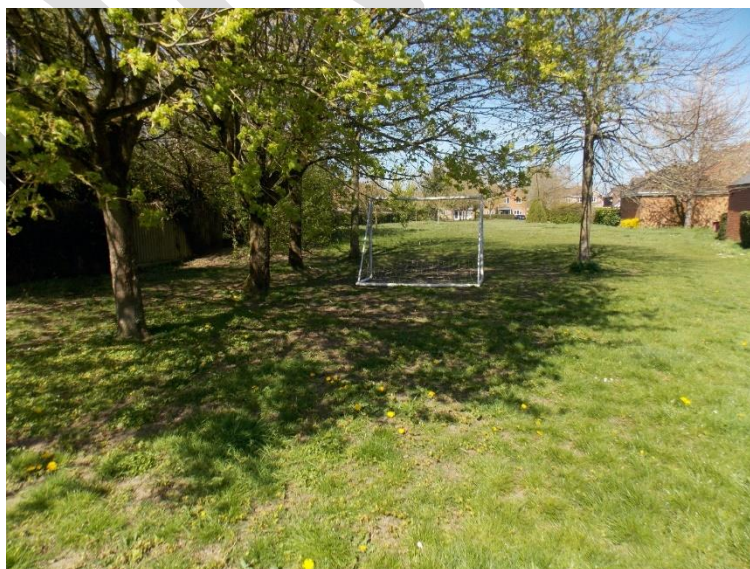

Charborough Green

LGS3: Churchill Close

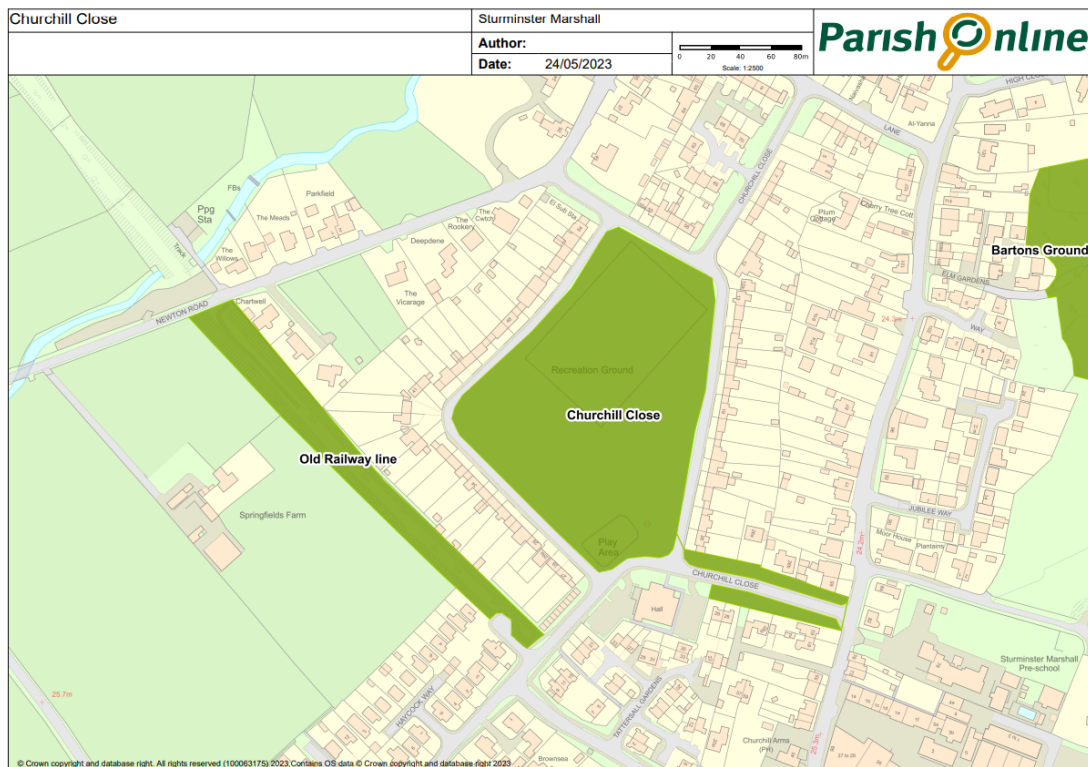

This open space was designed as an integral part of the original plan for local authority housing in the early 1950s.

Churchill Close is the main formal and informal recreation centre for Sturminster Marshall village. It is currently the location for both adult and junior football. A cricket square was formerly also present. At one side of the site is a children's play area. In the past, the site was used as the focus for major social events such as carnivals and flower shows.

Meeting the criteria

Churchill Close is in the heart of Sturminster Marshall village and, indeed, the developing Dorset Council Local Plan has suggested that any future retail development should be located in close proximity to it to provide a true village centre.

The open nature of the site and lack of features other than mown grassland means that it has a very low wildlife value and cannot be regarded as scenic in the same way as the surrounding Green Belt. However, when taken in the context of the surrounding local authority-built housing, it does have a distinctive character which defines this part of the village. As such it has considerable historic and cultural significance.

The main value of Churchill Close is its use for organised sport for both adults and children. Without it, there would be no current locations in the village where such activities could take place.

In a household survey carried out by the Neighbourhood Plan Steering Committee, Churchill Close was the most valued of all the open spaces in the parish.

On recreational grounds alone, Churchill Close should qualify for Local Green Space designation: the additional cultural and historic context within which it is placed adds further weight to its case for inclusion.

Name of Local Green Space	Churchill Close	
Location / Grid reference	SY947998	
Size (in hectares)	2.36	
Settlement to which it relates	Sturminster Marshall village	<input type="checkbox"/> within Y <input type="checkbox"/> immediately adjoining <input type="checkbox"/> outside (specify distance)
Reason site identified for review	A large public open space within the heart of the village	
Accessibility	<input type="checkbox"/> public open space Y <input type="checkbox"/> footpaths / bridleways	<input type="checkbox"/> commonland / permissive <input type="checkbox"/> clear views into site
Current use and general description	Used for both formal and informal recreation by all ages	
Qualities	High / Med / Low	Notes / Explanation
Landscape quality / importance (eg in key view from a public area)	M	This open space was designed as an integral part of the original plan for local authority housing in the early 1950s and, thus, defines the character of this part of Sturminster Marshall
Historic or cultural significance	L	The site holds no features of special historical significance. Its cultural value is associated with the vision of those overseeing the development of the public housing scheme
Recreational value (can include places valued for their tranquillity)	H	This is the main centre for both adult and junior football. A cricket square was formerly also present. At one side of the site is a children's play area. In the past, the site was used as the focus for major social events (eg carnivals and flower

		shows) and is thus part of the cultural heritage of village life.
Wildlife value	L	
Any existing development consents?	No	
Landowner details (if known) and any feedback (once contacted)	Sturminster Marshall Parish Council	
Public interest (if evidenced eg local 'friends' group)	This was the most valued of green open spaces by respondents to the household questionnaire	



Churchill Close



Churchill Close Children's Play Area

LGS4: Commons within the Conservation Area

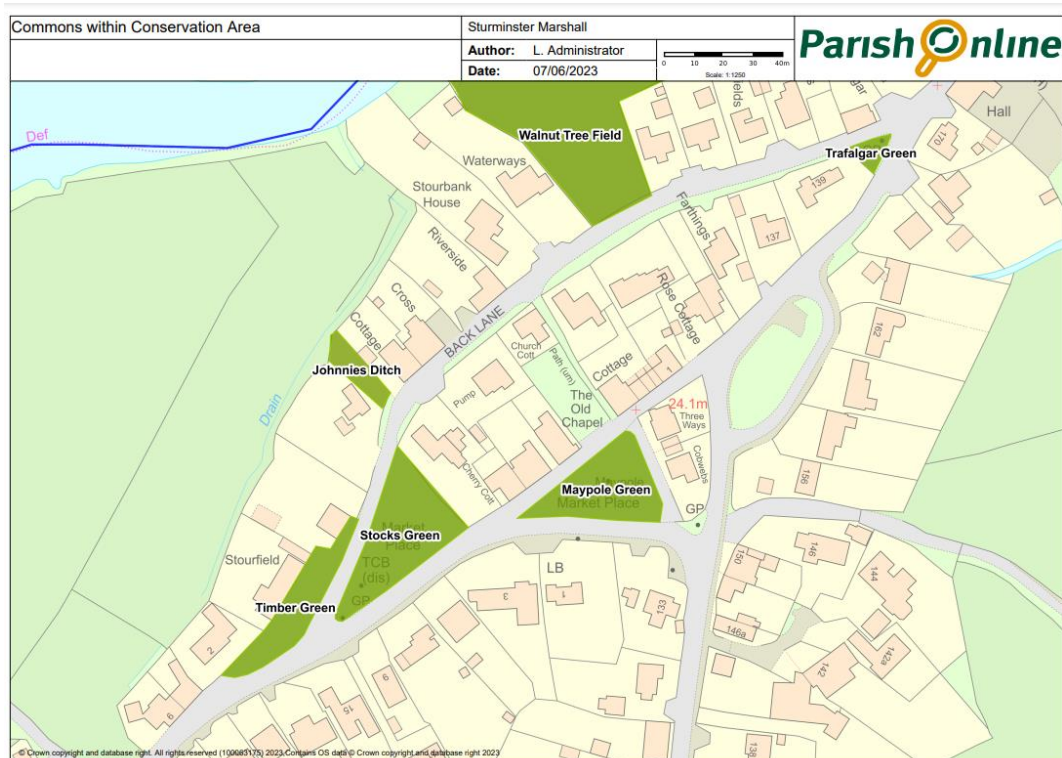

This is the collective name we have applied to three connected areas of mown grassland bounded by Kings Street, Front Lane and Back Lane: Timber Green (LGS4A), Stocks Green (LGS4B) and Maypole Green (LGS4C), together with Trafalgar Green (LGS4D) which is a small triangular grassy verge at the junction of Church Street and Back Lane. As part of the Sturminster Marshall Conservation Area these greens are bordered by some of the oldest buildings in the village.

They are important meeting places (historically) and have a number of mature trees, with oaks commemorating; Queen Victoria's jubilee, the coronation of Edward VII, the centenary of the Battle of Trafalgar, the coronation of George V, and the Armistice of 1918. A horse chestnut was also planted on Stocks Green to mark the coronation of George VI. There is a maypole (with seating at its base) topped by the village emblem of a water rat on Maypole Green, as well as a red telephone box, used as a book exchange, and a set of reproduction stocks on Stocks Green. Timber Green, as the name implies was formerly used for storing timber. Close by Stocks Green is Johnnies Ditch, a location where drovers used to take stock to drink from the river: the site has been recognised as of special value within the conservation area by Sturminster Marshall Parish Council.

Meeting the criteria

The greens are areas of permanent grassland with a number of broadleaf plant species in the heart of the old village and, because they are bounded by roads, are readily accessible.

The setting within the conservation area and the presence of mature trees mean that Maypole Green and Stocks Green/Timber Green have a high visual amenity value. A differential mowing regime, leaving some areas uncut creates a greater range of vegetation heights and provides suitable conditions for a greater diversity of invertebrates.

These areas all have obvious historic and cultural values as they relate to historic use and custom. The emblematic maypole on Maypole Green is still used for annual maypole dancing by pupils of the village First School.

The scenic value and the historical connections qualify these sites for inclusion as Local Green Spaces. As they are already registered as Common Land and are within the Conservation Area, they do have a measure of protection but we feel that designation as Local Green Spaces will re-enforce this protection.

Characterisation

These greens fall within the MG6 (*Lolium perenne-Cynosurus cristatus*) community of the National Vegetation Classification. It is a common community of circum-neutral, damp, fairly fertile soils in lowland England.

Maypole Green, Stocks Green and Timber Green are treated as a single unit in this characterisation.

Indicative list of flowering plants present.

<i>Lolium perenne</i>	Perennial Rye-grass
<i>Agrostis stolonifera</i>	Creeping Bent
<i>Festuca rubra</i>	Red Fescue
<i>Poa pratensis</i>	Meadow-grass
<i>Poa annua</i>	Annual Meadow grass
<i>Poa trivialis</i>	Rough Meadow-grass
<i>Bromus hordeaceus</i>	Soft Brome
<i>Holcus lanatus</i>	Yorkshire Fog
<i>Anthoxanthum odoratum</i>	Sweet Vernal-grass
<i>Ranunculus repens</i>	Creeping Buttercup
<i>Bellis perennis</i>	Daisy
<i>Plantago lanceolata</i>	Ribwort Plantain
<i>Achillea millefolium</i>	Yarrow
<i>Lamium purpureum</i>	Red Deadnettle
<i>Medicago lupulina</i>	Black Medick
<i>Geranium molle</i>	Dove's-foot Cranes-bill
<i>Geranium pratense</i>	Meadow Crane's-bill
<i>Trifolium repens</i>	White Clover
<i>Cerastium holosteoides</i>	Common Mouse-ear
<i>Rumex acetosa</i>	Common Sorrel
<i>Rumex obtusifolius</i>	Broad-leaved Dock
<i>Rumex conglomeratus</i>	Clustered Dock
<i>Heracleum sphondylium</i>	Hogweed

<i>Anthriscus sylvestris</i>	Cow Parsley
<i>Allium vineale</i>	Wild Onion
<i>Viola odorata</i>	Sweet Violet
<i>Hypochoeris radicata</i>	Common Cat's-ear
<i>Taraxacum officinale</i>	Dandelion
<i>Veronica chamaedrys</i>	Germander Speedwell

In addition, Maypole Green has three pedunculate Oak (*Quercus robur*) trees, Stocks Green has 3 oaks and one Horse-Chestnut (*Aesculus hippocastanum*) and Timber Green has one Horse Chestnut.

Name of Local Green Space	Market Place, comprising Maypole Green, Stocks Green and Timber Green	
Location / Grid reference	ST9490020 & ST949002	
Size (in hectares)	0.24	
Settlement to which it relates	Sturminster Marshall village	<input type="checkbox"/> within Yes <input type="checkbox"/> immediately adjoining <input type="checkbox"/> outside (specify distance)
Reason site identified for review	Local recreational and cultural value	
Accessibility	<input type="checkbox"/> public open space Y <input type="checkbox"/> footpaths / bridleways	<input type="checkbox"/> commonland / permissive <input type="checkbox"/> clear views into site
Current use and general description	Informal recreation. Three areas of mown grass with commemorative trees, a maypole (bearing the village emblem of a water rat) and a set of reproduction stocks	
Qualities	High / Med / Low	Notes / Explanation
Landscape quality / importance (eg in key view from a public area)	M	As part of the Sturminster Marshall Conservation Area these greens are bordered by some of the older buildings in the village, whilst the specimen trees provide an air of seclusion

Historic or cultural significance	H	The greens have high cultural significance as they relate to historic use and custom. The emblematic maypole on Maypole Green is still used for annual maypole dancing by pupils of the First School.
Recreational value (can include places valued for their tranquillity)	M	Quiet areas within the Conservation Area
Wildlife value	L	The areas are of mown grass, affording little wildlife value, though the trees do give some structural and biological diversity.
Any existing development consents?	No	
Landowner details (if known) and any feedback (once contacted)	Sturminster Marshall Parish Council (Common land)	
Public interest (if evidenced eg local 'friends' group)	These greens (together with the very much smaller Trafalgar Green) are within the conservation area and all have memorial trees	
Other notes eg links to footpath network, boundary definition etc,	Trees on these greens commemorate the centenary of the Battle of Trafalgar (Trafalgar Green), Queen Victoria's Diamond Jubilee (Maypole Green) and King Edward VII's coronation (Stocks Green)	



Stocks Green & Timber Green



Maypole Green



Trafalgar Green

LGS5: The Old Railway Line

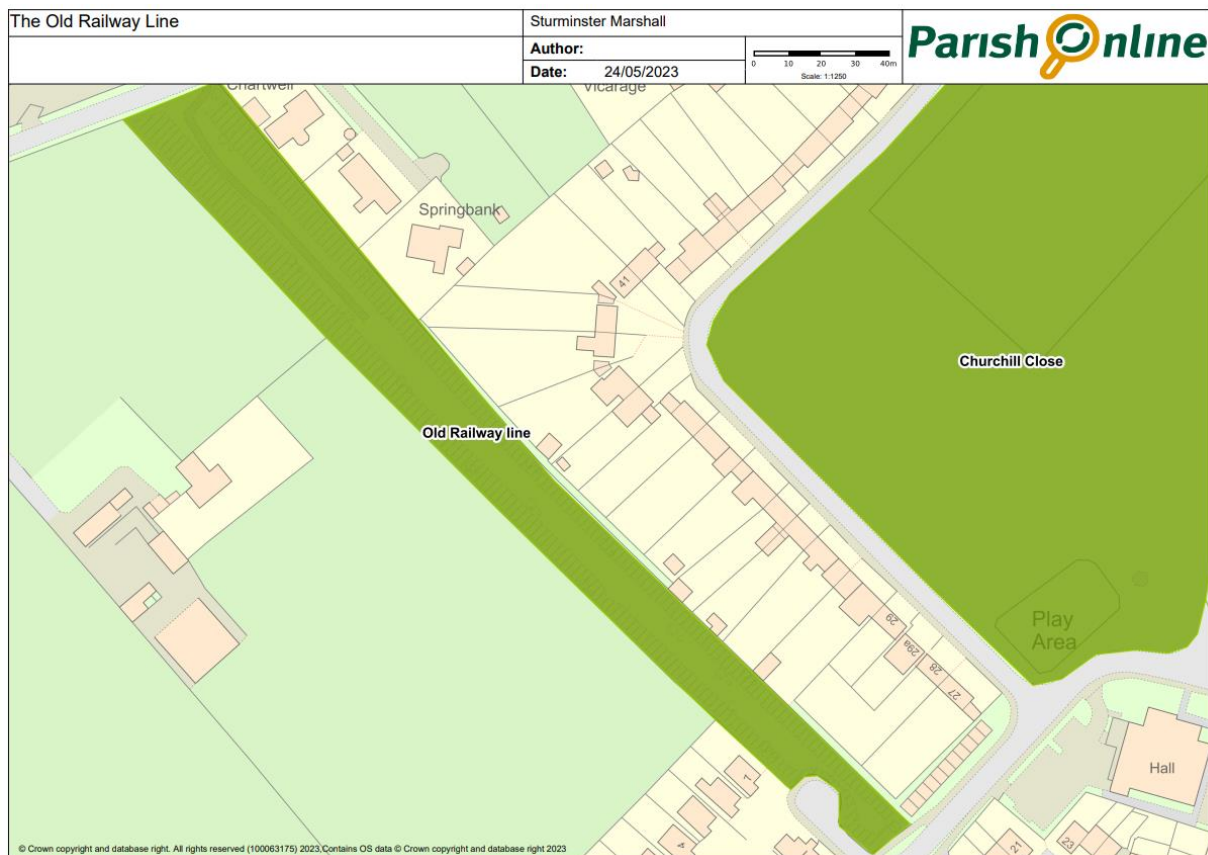

This site is part of the old trackbed of the former Somerset & Dorset Railway line and provides a connection between Newton Road and Railway Drive. Currently it is an isolated section of the North Dorset Trailway. It is hoped that, in the future, connections can be made with sections leading northwards to Spetisbury and south-eastwards to Corfe Mullen. The site consists of a footpath, verge and hedgerows providing habitat for a range of common species.

Meeting the criteria

The site is within the village envelope and readily accessible from both ends. From its elevated position it does give views across the fields of Springfield Farm and out towards Newton Peveril.

Its cultural and historic significance lies in the fact that it is part of the former railway system.

It is not of especially high wildlife value, though the combination of trees, shrubs and verge vegetation does make a useful contribution to the overall biodiversity of the parish. Distinctive early-succession communities at the northern end of the site, a product of replacing steps with an access ramp, add further species diversity.

The site is well-used by walkers and dog walkers.

The combination of features above make this location suitable for designation as a Local Green Space.

Characterisation

A wide, bare earth path on the top of an embankment.

The embankment carries a variety of trees and shrubs, mainly Sycamore (*Acer pseudoplatanus*), Hawthorn (*Crataegus monogyna*) and Field Maple (*Acer campestre*) with smaller numbers of Ash (*Fraxinus excelsior*), Wytch Elm (*Ulmus glabra*), Rowan (*Sorbus aucuparia*) and Cherry Plum (*Prunus cerasifera*). Also present is a patch of Cypress (*Cupressus* sp.).

Much of the area below the tree cover is relatively bare, with patchy distribution of a number of species which are locally dominant:

<i>Hedera helix</i>	Ivy
<i>Urtica dioica</i>	Stinging Nettle
<i>Arum maculatum</i>	Cuckoo-pint
<i>Ranunculus ficaria</i>	Lesser Celandine
<i>Veronica hederifolia</i>	Ivy-leaved Speedwell
<i>Dactylis glomerata</i>	Cock's-foot
<i>Arrhenatherum elatius</i>	False Oat-grass
<i>Rubus fruticosus</i> agg.	Bramble
<i>Geum urbanum</i>	Wood Avens
Other species include:	
<i>Heracleum sphondylium</i>	Hogweed
<i>Bellis perennis</i>	Daisy
<i>Allium triquetrum</i>	Three-sided Leek
<i>Anthriscus sylvestris</i>	Cow Parsley
<i>Ranunculus repens</i>	Creeping Buttercup
<i>Rumex crispus</i>	Curled Dock
<i>Rumex sanguineus</i>	Wood Dock
<i>Primula vulgaris</i>	Primrose
<i>Lamium album</i>	White Deadnettle
<i>Galium aparine</i>	Cleavers
<i>Dipsacus fullonum</i>	Teasel
<i>Iris foetidissima</i>	Stinking Iris
<i>Viola odorata</i>	Sweet Violet
<i>Chamerion angustifolium</i>	Rosebay Willow-herb
<i>Poa pratensis</i>	Meadow-grass
<i>Poa annua</i>	Annual Meadow-grass
<i>Poa trivialis</i>	Rough Meadow-grass
<i>Brachypodium sylvaticum</i>	False Brome
<i>Pentaglottis sempervirens</i>	Alkanet
<i>Veronica agrestis</i>	Green Field Speedwell
<i>Vicia sativa</i>	Common Vetch

<i>Festuca pratensis</i>	Meadow Fescue
<i>Holcus lanatus</i>	Yorkshire Fog
<i>Anisantha sterilis</i>	Barren Brome

Some garden escape species are also present such as Spanish bluebell and cultivated varieties of *Primula* and yellow archangel.

At the northern end of the railway line, where a slope has replaced the former steps, early successional plants are found on the exposed chalk fill of the embankment. These include:

<i>Leucanthemum vulgare</i>	Oxeye Daisy
<i>Lonicera periclymenum</i>	Honeysuckle
<i>Rubus fruticosus</i> agg.	Bramble
<i>Chamerion angustifolium</i>	Rosebay Willow-herb
<i>Primula vulgaris</i>	Primrose
<i>Geum urbanum</i>	Wood Avens
<i>Taraxacum officinalis</i>	Dandelion
<i>Fragaria vesca</i>	Strawberry
<i>Ranunculus repens</i>	Creeping Buttercup
<i>Galium aparine</i>	Cleavers
<i>Geranium molle</i>	Dove's-foot Cranes-bill
<i>Medicago lupulina</i>	Black Medick
<i>Agrostis stolonifera</i>	Creeping Bent
<i>Holcus lanatus</i>	Yorkshire Fog
<i>Dactylis glomerata</i>	Cock's-foot
<i>Sonchus asper</i>	Prickly Sow-thistle
<i>Crepis biennis</i>	Rough Hawk's-beard
<i>Alliaria petiolata</i>	Garlic Mustard
<i>Digitalis purpurea</i>	Foxglove
<i>Trifolium repens</i>	White Clover
<i>Trifolium pratense</i>	Red Clover
<i>Lotus corniculatus</i>	Bird's-foot Trefoil
<i>Vicia hirsuta</i>	Hairy Tare
<i>Rumex conglomeratus</i>	Clustered Dock
<i>Centaurea nigra</i>	Knapweed
<i>Dipsacus fullonum</i>	Teasel

<i>Plantago lanceolata</i>	Ribwort Plantain
<i>Plantago major</i>	Greater Plantain
<i>Hedera helix</i>	Ivy
<i>Linaria purpurea</i>	Purple Toadflax (garden escape)

Together with seedlings of *Aesculus pseudoplatanus* (sycamore) and young plants of *Crataegus monogyna* (hawthorn)

Name of Local Green Space	Old Railway Line	
Location / Grid reference	SY945998 to SY947996	
Size (in hectares)	0.62	
Settlement to which it relates	Sturminster Marshall village	<input type="checkbox"/> within Yes <input type="checkbox"/> immediately adjoining <input type="checkbox"/> outside (specify distance)
Reason site identified for review	Heritage value as part of defunct Somerset & Dorset Railway, recreational value and wildlife	
Accessibility	<input type="checkbox"/> public open space Y <input type="checkbox"/> footpaths / bridleways	<input type="checkbox"/> commonland / permissive <input type="checkbox"/> clear views into site
Current use and general description	Currently used as a footpath connecting two parts of village	
Qualities	High / Med / Low	Notes / Explanation
Landscape quality / importance (eg in key view from a public area)	L	
Historic or cultural significance	M	Historical value as part of old railway system

Recreational value (can include places valued for their tranquillity)	M	A quiet walking area within the main body of the village. It forms part of a link to the more extensive trailway to North Dorset
Wildlife value	M	A footpath, verge and hedgerows providing habitat for a range of common species and providing a link to more extensive linear features towards Spetisbury
Any existing development consents?	Yes / No	NO
Landowner details (if known) and any feedback (once contacted)	Owned by Dorset Council and managed by the Dorset Countryside Team	
Public interest (if evidenced eg local 'friends' group)		
Other notes eg links to footpath network, boundary definition etc,	Part of the, currently discontinuous, trailway	



Old Railway Line



Northern End of Old Railway Line

LGS6: Walnut Tree Field

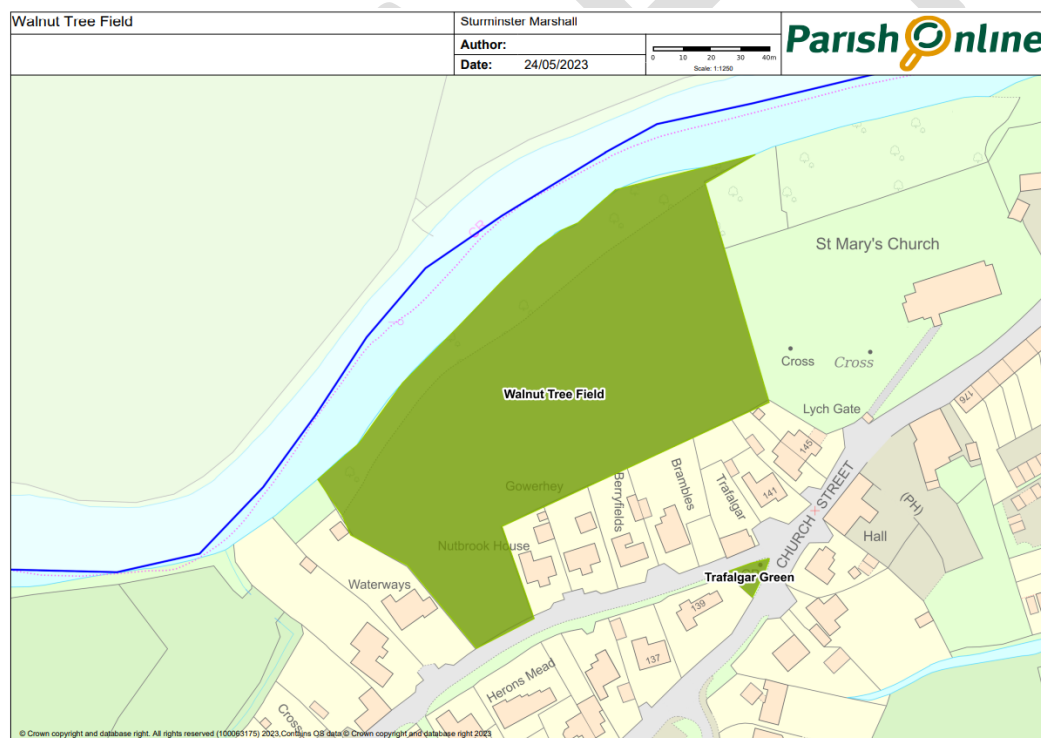

The site is within the Sturminster Marshall Conservation Area with views across the Stour valley and adjacent to St Mary's Church and the churchyard. The field is a Scheduled Ancient Monument of archaeological value, containing the buried remains of a medieval village field system. It is also a registered Local Nature Reserve.

Walnut Tree Field was, in the past, referred to as "The Orchard," An old apple tree provides a clue to its former designation whilst the presence of an old (estimated to be about 300 years) walnut tree (*Juglans regia*) is the defining feature of the field and is held to be of significant local value. A number of younger apple trees have been planted in the field in recent years.

This is a location for quiet recreational activity with access to the River Stour. High value to the community as a much-used space for walking and dog walking throughout the year and in the warmer months it is used for bathing in the river and for some water sports. It is also valued for its wildlife and tranquility. The combination of grassland, the river and its marginal vegetation provides a measure of diversity for wildlife and the management objectives of the Dorset Countryside Team are to maximise this value by appropriate mowing regimes.

Meeting the criteria

The field is adjacent to the older part of the village, designated as a conservation area, and close by the Conservation Area Commons. Thus it is readily accessible.

The scenic value of the site is partly determined by its proximity to St Mary's Church but mainly a result of its location at the side of the River Stour, with additional views across to the fields on the further bank and more the distant higher ground towards Badbury Rings and the Cranborne Chase and West Wiltshire Downs AONB.

The historic context is recognised by its listing as a Scheduled Ancient Monument.

The wildlife value of the site is based on the combination of grassland, river and riverside communities. The objectives of management are to enhance this value further by a mowing regime that leaves areas with taller vegetation.

It is an area for quiet recreation, though some river-based activities do also take place on a limited scale. It is also seen as an important area for people to interact with, and learn about, wildlife.

The historic, wildlife and recreational importance of the Walnut Tree Field make it highly suitable for designation as a Local Green Space.

Characterisation

Walnut Tree Field is an area of MG1 (*Arrhenatherum elatius* grassland), using the National Vegetation Classification. Current management consists of mowing well-defined pathways between blocks of taller vegetation, left unmown to encourage a wider diversity of invertebrates which, in turn should encourage a wider diversity of vertebrates.

Within the field the grassland community is locally dominated by different species, giving a mosaic of habitats.

Indicative species list

<i>Arrhenatherum elatius</i>	False Oat-grass
<i>Dactylis glomerata</i>	Cock's-foot
<i>Alopecurus pratensis</i>	Meadow Foxtail
<i>Lolium perenne</i>	Rye-grass
<i>Poa pratensis</i>	Meadow-grass
<i>Holcus lanatus</i>	Yorkshire Fog
<i>Festuca rubra</i>	Red Fescue
<i>Festuca arundinacea</i>	Tall Fescue
<i>Urtica dioica</i>	Stinging Nettle
<i>Anthriscus sylvestris</i>	Cow Parsley
<i>Heracleum sphondylium</i>	Hogweed

<i>Geranium pratensis</i>	Meadow Crane's-bill
<i>Ranunculus repens</i>	Creeping Buttercup
<i>Ranunculus acris</i>	Meadow Buttercup
<i>Taraxacum officinale</i>	Dandelion
<i>Galium aparine</i>	Cleavers
<i>Ranunculus ficaria</i>	Lesser Celandine
<i>Plantago lanceolata</i>	Ribwort Plantain
<i>Rumex obtusifolius</i>	Broad-leaved Dock
<i>Rumex conglomeratus</i>	Clustered Dock
<i>Bellis perennis</i>	Daisy
<i>Trifolium repens</i>	White clover
<i>Rumex acetosa</i>	Common Sorrel
<i>Rubus fruticosus</i>	Bramble
<i>Capsella bursa-pastoris</i>	Shepherd's Purse
<i>Lamium album</i>	White Deadnettle
<i>Arum maculatum</i>	Cuckoo-pint
<i>Geranium molle</i>	Dove's-foot crane's-bill
<i>Veronica chamaedrys</i>	Germander Speedwell
<i>Pentaglottis sempervirens</i>	Alkanet
<i>Lamium purpureum</i>	Red Deadnettle
<i>Rosa canina</i>	Dog Rose
<i>Cerastium holostioides</i>	Common Mouse-ear
<i>Leucanthemum vulgare</i>	Ox-eye Daisy

A number of garden escapes can be found close to the fence separating the field from the gardens of houses in Back Lane.

The vegetation changes beside the river and is dominated by willow and elm trees with a distinctive ground flora

<i>Salix fragilis</i>	Crack Willow
<i>Ulmus glabra</i>	Wytch Elm
<i>Acer campestre</i>	Field Maple
<i>Oenanthe crocata</i>	Hemlock Water-dropwort
<i>Urtica dioica</i>	Stinging Nettle
<i>Symphytum officinale</i>	Common Comfrey

<i>Phalaris arundinacea</i>	Reed Canary-grass
<i>Ranunculus ficaria</i>	Lesser Celandine
<i>Ranunculus repens</i>	Creeping Buttercup
<i>Galium aparine</i>	Cleavers
<i>Lolium perenne</i>	Rye-grass
<i>Rubus fruticosus</i>	Bramble
<i>Hedera helix</i>	Ivy
<i>Capsella bursa-pastoris</i>	Shepherd's Purse
<i>Alliaria petiolata</i>	Garlic Mustard
<i>Poa trivialis</i>	Rough Meadow-grass
<i>Myosotis scorpioides</i>	Water Forget-me-not
<i>Cardamine flexuosa</i>	Wavy Bitter-cress
<i>Symphycarpos albus</i>	Snowberry (possible garden escape)

The riverside setting also contributes to the diversity of birdlife including species such as Heron (*Ardea cinerea*), Kingfisher (*Alcedo atthis*) and Little Egret (*Egretta garzetta*), as well as Swallow (*Hirundo rustica*), Chiffchaff (*Phylloscopus collybita*), Blackcap (*Sylvia atricapilla*) and Sedge Warbler (*Acrocephalus schoenobaenus*). Waterside insects such as Common Mayfly (*Ephemera Danica*) and Banded Demoiselle (*Calopteryx splendens*) may also be seen here.

Name of Local Green Space	Walnut Tree Field	
Location / Grid reference	ST9500004	
Size (in hectares)	1.20	
Settlement to which it relates	Sturminster Marshall village	<input type="checkbox"/> within <input type="checkbox"/> immediately adjoining <input type="checkbox"/> outside (specify distance)
Reason site identified for review	Cultural significance and recreational value, being the only public open space with access to the river	
Accessibility	<input type="checkbox"/> public open space Y <input type="checkbox"/> footpaths / bridleways	<input type="checkbox"/> commonland / permissive <input type="checkbox"/> clear views into site
Current use and general description	Informal recreation. This is an area of lowland mesotrophic grassland bordering the River Stour.	
Qualities	High / Med / Low	Notes / Explanation
Landscape quality / importance (eg in key view from a public area)	M	The site is within the Sturminster Marshall Conservation Area with views across the Stour valley and adjacent to St Mary's Church and the churchyard
Historic or cultural significance	H	The field is a Scheduled Ancient Monument with archaeological value, with buried remains of a medieval village
Recreational value (can include places valued for their tranquillity)	H	A location for quiet recreational activity with access to the River Stour. The old Walnut Tree in the centre of the field is regarded as a feature of note for local people

Wildlife value	M	The combination of grassland, the river and its marginal vegetation provides a measure of diversity for wildlife
Any existing development consents?	Yes / No	No
Landowner details (if known) and any feedback (once contacted)	Owned by Dorset Council and managed by the Dorset Countryside Team	
Public interest (if evidenced eg local 'friends' group)	Noted as a location of significant value in responses to the household questionnaire	



Walnut Tree Field

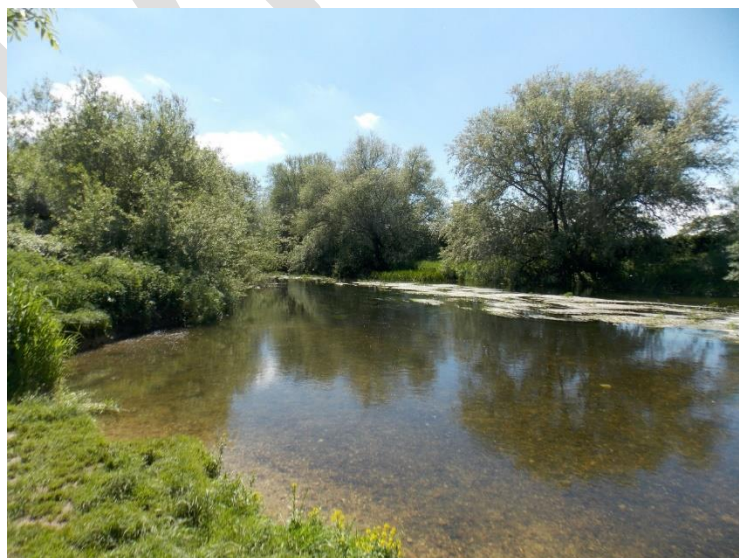

River Stour at Walnut Tree Field

Appendix A. Responses from Household Questionnaire

Answers to Question 36 Valued green spaces (number of respondents)

Churchill Close	133
Walnut Tree Field	99
Charborough Green	70
Maypole Green	51
Barton's Ground	47
Stocks Green/Timber Green	33
Footpaths/bridleways	14
Golf Course and paths round it	12
Fields around village (possibly some double counting with footpaths)	11
Old railway line	10
Riverside	9
Moor Lane	6
Millmoor	3
Arch Ground	2
Mapperton fields	1
Lamplands	1
All green spaces	64
None	4
Nil return to this question	51
Other comments ref value of open spaces with no specifics	5

Of those saying that none were valuable, 2 were from Jubilee Cross and 2 from the main village

Of the nil returns, 3 were from Henbury, 3 from Mapperton/Almer and 8 from Jubilee Cross. The remaining 37 were from the main village.

Of those 70 valuing Charborough Green, and mentioning it specifically, 30 were from post codes in the immediate vicinity. Of the remaining respondents, 11 replied "both of the above." This may have been because these were the only two valued or because the respondents did not realise that these were examples, rather than specific references. The question asked which green spaces, (eg Churchill Close and Charborough Green) were valued.

Appendix B. Sample letter to landowners

STURMINSTER MARSHALL PARISH COUNCIL

CHAIRMAN: HILARY PALMER

Parish Clerk: Alison Clothier

28 Landers Reach

Lytchett Matravers

Poole

Dorset

BH16 6NB

Tel: 07469780548

28th July 2021

Dear [REDACTED],

RE: Local Green Space – Landowner Notification

As you may be aware, Sturminster Marshall Parish Council has been working to create a Neighbourhood Plan to help guide development of the parish over the next 12-15 years. This will be an important planning document helping to identify land that may be suitable for development and areas which should be given some form of protection. One means of affording such protection is by nominating sites as Local Green Spaces.

Successful designation of a site as a Local Green Space would mean that any new development on the land would not be possible except in “very exceptional circumstances” as defined in the National Planning Policy Framework.

In line with nationally-defined criteria, to be suitable for designation the Local Green Space must be

1. In reasonably close proximity to the community it serves
2. Demonstrably special to the local community and hold a particular significance, for example because of its beauty, historical significance, recreational value, tranquillity or richness of wildlife
3. Local in character and not an extensive tract of land.

Following consultation through an initial public event followed up by a household questionnaire, we have identified a number of candidate sites.

I am writing to inform you that your site, [REDACTED] has been nominated as a Local Green Space.

Formal consultation on aspects of the draft Neighbourhood Plan will take place later in 2021 and in 2022 the draft plan, as a whole, will be open for consultation. At this stage, we wish to make you aware of our thinking

and to give you the opportunity to comment on the inclusion of your site in the draft plan. Should you wish to discuss the implications of this nomination with us, please do not hesitate to contact me.

Yours sincerely,

AClothier

Alison Clothier, Parish Clerk for Sturminster Marshall Parish Council

DRAFT

16. APPENDIX 4– WILDLIFE AND HABITATS DATA

16.1 INTERNATIONALLY IMPORTANT SITES

16.1.1 The nearest designated site is an area of heathland known as Corfe Mullen Pastures, which lies approximately 210m East of the plan area. This forms an outlier of the Dorset Heathlands which are covered by several international and national designations including SPA, SAC Ramsar and SSSI. More extensive areas of heathland are present at Upton Heath which is approximately 1.2km south-east of the nearest point of the Neighbourhood Plan area.

16.1.2 Due to proximity of these sites, much of the southern and eastern parts of the plan area lie within the 5km buffer zone surrounding the designated Dorset Heathlands area. This means care is needed to ensure that any development within the Neighbourhood Plan area does not risk harm to these sites by increasing recreational pressures through activities such as dog-walking. Such pressures can be alleviated by the creation of appropriate Suitable Alternative Natural Green Spaces (SANGs). Advice on this issue is provided in the Dorset Heathlands Planning Framework³⁴.

Map 14. Dorset Heathland impact zones

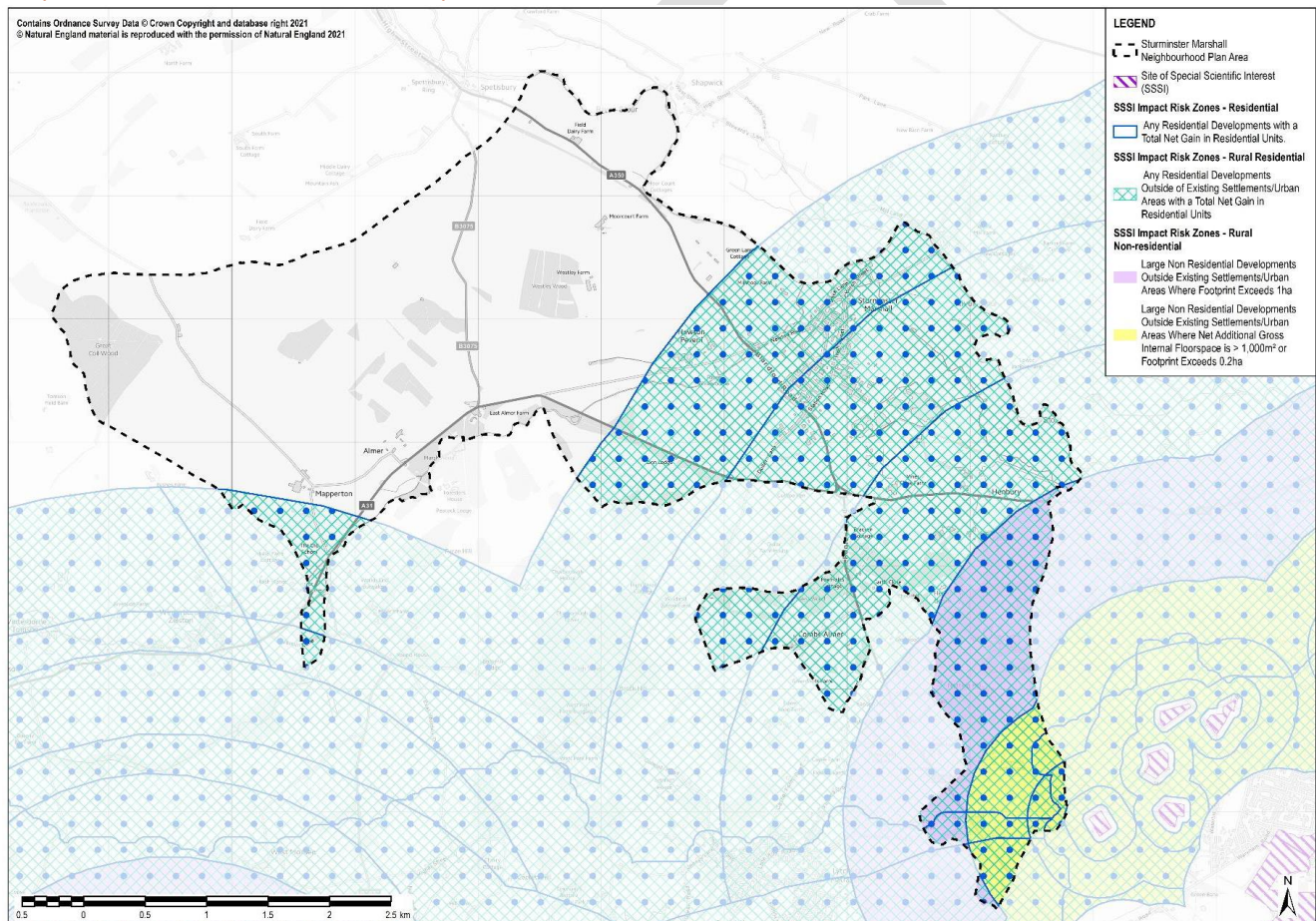

16.1.3 A small section of the south of the Plan area, including part of Jubilee Cross, is also within the Poole Harbour catchment. The Poole Harbour SPA, Ramsar and SSSI is approximately 2.5km south of the Plan area, at its nearest point. The wildlife and habitats in Poole Harbour are vulnerable increasing nutrient loads from the rivers draining into it. Advice on this issue is provided in the Nitrogen Reduction in Poole Harbour

³⁴ Dorset Heathlands Planning Framework 2020 - 2025 Supplementary Planning Document, April 2020
<https://www.dorsetcouncil.gov.uk/planning-buildings-land/planning-policy/supplementary-planning-documents-and-guidance/all-of-dorset/dorset-heathlands-planning-framework>

Supplementary Planning Document³⁵. Concerns have also been raised regarding additional recreational pressures, but at present the catchment for which mitigation is sought does not extend into the Sturminster Marshall Neighbourhood Plan area³⁶.

16.2 OTHER NATIONALLY IMPORTANT SITES

16.2.1 Some northern parts of the parish (broadly north of the line of the former Roman Road) lie within the outer consultation zone surrounding the Bryanston Greater Horseshoe Bat SSSI. Any development within this zone would need to conform to restrictions detailed in the Dorset Biodiversity Appraisal Protocol guidance³⁷.

Map 15. Bryanston Greater Horseshoe Bat consultation zones

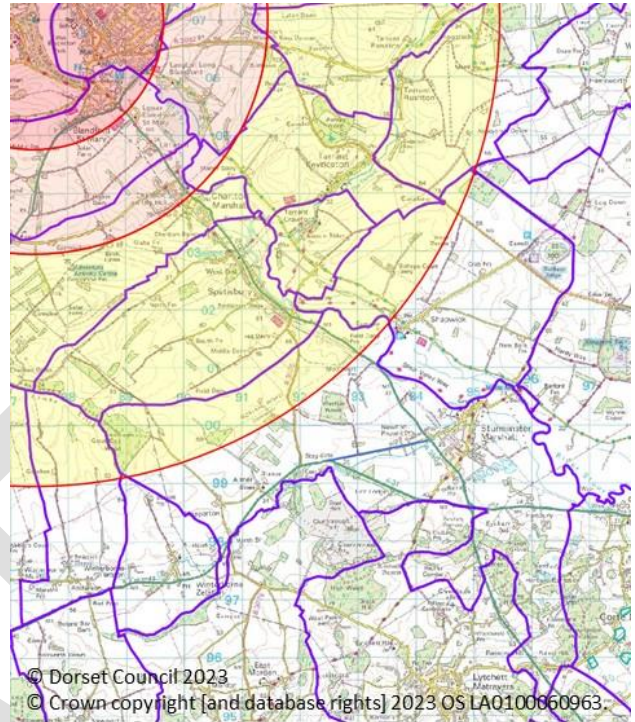

16.3 LOCALLY IMPORTANT SITES

16.3.1 In addition to these European and National wildlife designations outside the Plan area, there are several Sites of Nature Conservation Interest (SNCIs), identified in cooperation with local landowners, within the Plan boundary. These are listed in the following table, and identified on the Map 8 in the main body of the report.

Name of SNCI	Area (ha)	Description
Dullar/West Woods	4.17	Mainly mixed woodland on a sand and clay soil.
Elder Moor	19.66	A varied area of woodland habitats with a rich flora. Extends beyond the parish boundary.
Great Coll Wood*	55.50	Semi-natural deciduous woodland and conifer plantation. Registered Ancient Woodland
Henbury Farm Wood	1.84	Semi-natural deciduous woodland. Registered Ancient Woodland
Higher Sandy Coppice	1.91	A small acidic oak wood.
Rushall House	1.84	A small but varied site of acid grassland and heathland habitats.
Sturminster Marshall Ponds	0.06	A series of ponds with populations of great crested newts.
West Wood/ Foxholes Wood	5.54	Deciduous woodland on an acid soil.
Westley Wood	9.04	Semi-natural deciduous woodland.

³⁵ Dorset Heathlands Planning Framework 2020 - 2025 Supplementary Planning Document, April 2020 <https://www.dorsetcouncil.gov.uk/planning-buildings-land/planning-policy/supplementary-planning-documents-and-guidance/all-of-dorset/dorset-heathlands-planning-framework>

³⁶ Based on Poole Harbour Recreation Supplementary Planning Document, April 2020 <https://www.dorsetcouncil.gov.uk/planning-buildings-land/planning-policy/supplementary-planning-documents-and-guidance/poole-harbour-recreation-spd>

³⁷ Currently Nitrogen Reduction in Poole Harbour Supplementary Planning Document, April 2017 (but due to be refreshed) <https://www.dorsetcouncil.gov.uk/web/guest/-/nitrogen-reduction-in-poole-harbour>

16.4 PROTECTED SPECIES

16.4.1 Plant and animal species recorded in the parish include a number which have designated protection status at different levels. There are also species which are described as notable for Dorset and may be used as indicators of habitat quality. These are listed in the following table, using data supplied by the Dorset Environmental Records Centre.

Significant plant and animal species recorded in the parish.

(Data supplied by, and printed with permission of, Dorset Environmental Records Centre)

DORSET NOTABLES & INVASIVE SPECIES RECORDS		Positive	Negative
<i>Sphagnum squarrosum</i>	Spiky Bog-moss		
<i>Rhytidiadelphus triquetrus</i>	Big Shaggy-moss	DN	
<i>Osmunda regalis</i>	Royal Fern	DN	
<i>Polystichum aculeatum</i>	Hard Shield-fern	DN	
<i>Orchis mascula</i>	Early-purple Orchid	DN	
<i>Allium triquetrum</i>	Three-cornered Garlic		IPS
<i>Ruscus aculeatus</i>	Butcher's-broom	DN	
<i>Luzula Pilosa</i>	Hairy Wood-rush	DN	
<i>Carex hostiana</i>	Tawny Sedge	DN	
<i>Carex paniculate</i>	Greater Tussock-sedge	DN	
<i>Melica uniflora</i>	Wood Melick	DN	
<i>Caltha palustris</i>	Marsh-marigold	DN	
<i>Anemone nemorosa</i>	Wood Anemone	DN	
<i>Aquilegia vulgaris</i>	Columbine	DN	
<i>Potentilla anglica</i>	Trailing Tormentil	DN	
<i>Cotoneaster horizontalis</i>	Wall Cotoneaster		IPS
<i>Filipendula ulmaria</i>	Meadowsweet	DN	
<i>Plantago coronopus</i>	Buck's-horn Plantain	DN	
<i>Veronica montana</i>	Wood Speedwell	DN	
<i>Lamiastrum galeobdolon</i>	Yellow Archangel	DN	
<i>Lamiastrum galeobdolon subsp. argentatum</i>	Yellow Archangel		IPS
<i>Scutellaria minor</i>	Lesser Skullcap	DN	
<i>Origanum vulgare</i>	Wild Marjoram	DN	

<i>Lotus corniculatus</i>	Common Bird's-foot-trefoil	DN	
<i>Trifolium arvense</i>	Hare's-foot Clover	DN	
<i>Trifolium micranthum</i>	Slender Trefoil	DN	
<i>Trifolium subterraneum</i>	Subterranean Clover	DN	
<i>Impatiens capensis</i>	Orange Balsam		IPS
<i>Impatiens glandulifera</i>	Himalayan Balsam		IPS
<i>Primula veris</i>	Cowslip	DN	
<i>Lysimachia nemorum</i>	Yellow Pimpernel	DN	
<i>Lysimachia nummularia</i>	Creeping-Jenny	DN	
<i>Lysimachia vulgaris</i>	Yellow Loosestrife	DN	
<i>Rhododendron ponticum</i>	Rhododendron		IPS
<i>Vaccinium myrtillus</i>	Bilberry	DN	
<i>Fallopia japonica</i>	Japanese Knotweed		IPS
<i>Stellaria alsine</i>	Bog Stitchwort	DN	
<i>Myosoton aquaticum</i>	Water Chickweed	DN	
<i>Euonymus europaeus</i>	Spindle	DN	
<i>Euphorbia amygdaloides</i>	Wood Spurge	DN	
<i>Viola riviniana</i>	Common Dog-violet	DN	
<i>Hypericum androsaemum</i>	Tutsan	DN	
<i>Erodium cicutarium</i>	Common Stork's-bill	DN	
<i>Galium odoratum</i>	Woodruff	DN	
<i>Galium saxatile</i>	Heath Bedstraw	DN	
<i>Galium verum</i>	Lady's Bedstraw	DN	
<i>Leontodon hispidus</i>	Rough Hawkbit	DN	
<i>Leontodon saxatilis</i>	Lesser Hawkbit	DN	
<i>Pilosella officinarum</i>	Mouse-ear-hawkweed	DN	
<i>Pulicaria dysenterica</i>	Common Fleabane	DN	
<i>Leucanthemum vulgare</i>	Oxeye Daisy	DN	
<i>Senecio jacobaea</i>	Common Ragwort	DN	IPS
<i>Petasites fragrans</i>	Winter Heliotrope		IPS
<i>Adoxa moschatellina</i>	Moschatel	DN	

<i>Aeshna grandis</i>	Brown Hawker	DN	
<i>Aricia agestis</i>	Brown Argus	DN	
<i>Neovison vison</i>	American Mink	DN	IAS
<i>Cervus nippon</i>	Sika Deer		IAS
<i>Sciurus carolinensis</i>	Eastern Grey Squirrel		IAS

DN = Dorset notable as indicator of quality habitat

IPS = invasive plant species

IAS= invasive animal species

Species for which there is an International responsibility

<i>Dryopteris affinis</i>	Scaly Male-fern
<i>Hyacinthoides non-scripta</i>	Bluebell
<i>Carex binervis</i>	Green-ribbed Sedge
<i>Carex laevigata</i>	Smooth-stalked Sedge
<i>Ceratocarpus claviculata</i>	Climbing Corydalis
<i>Ulex gallii</i>	Western Gorse
<i>Conopodium majus</i>	Pignut

Nationally scarce plant species

<i>Thelypteris palustris</i>	Marsh Fern
<i>Helleborus foetidus</i>	Stinking Hellebore
<i>Lotus subbiflorus</i>	Hairy Bird's-foot-trefoil

Plant species scarce in Dorset

<i>Equisetum sylvaticum</i>	Wood Horsetail
-----------------------------	----------------

European Red List birds (of high conservation concern)

<i>Cuculus canorus</i>	Cuckoo
<i>Alauda arvensis</i>	Skylark
<i>Muscicapa striata</i>	Spotted Flycatcher
<i>Sturnus vulgaris</i>	Starling

European Amber list birds (of medium conservation interest)

<i>Cygnus olor</i>	Mute Swan
<i>Anas platyrhynchos</i>	Mallard
<i>Prunella modularis</i>	Dunnock
<i>Pyrrhula pyrrhula</i>	Bullfinch
<i>Emberiza schoeniclus</i>	Reed Bunting

Species vulnerable in England or GB (at high risk of extinction in the wild)

<i>Ranunculus flammula</i>	Lesser Spearwort
<i>Erinaceus europaeus</i>	West European Hedgehog

Species near threatened in England or GB (lower risk of extinction but may be so in the near future)

<i>Carex echinata</i>	Star Sedge
<i>Potentilla erecta</i>	Tormentil
<i>Fragaria vesca</i>	Wild Strawberry
<i>Veronica officinalis</i>	Heath Speedwell
<i>Lathyrus linifolius</i>	Bitter-vetch
<i>Calluna vulgaris</i>	Heather
<i>Erica cinerea</i>	Bell Heather
<i>Erica tetralix</i>	Cross-leaved Heath
<i>Silene flos-cuculi</i>	Ragged-Robin
<i>Oxalis acetosella</i>	Wood-sorrel
<i>Valeriana officinalis</i>	Common Valerian
<i>Knautia arvensis</i>	Field Scabious
<i>Sanicula europaea</i>	Sanicle
<i>Oenanthe lachenalii</i>	Parsley Water-dropwort
<i>Libellula fulva</i>	Scarce Chaser Dragonfly
<i>Lasiommata megera</i>	Wall Butterfly
<i>Ardea cinerea</i>	Grey Heron
<i>Phalacrocorax carbo</i>	Cormorant
<i>Accipiter gentilis</i>	Goshawk
<i>Streptopelia decaocto</i>	Collared Dove
<i>Corvus frugilegus</i>	Rook

17. APPENDIX 5 – NON-DESIGNATED HERITAGE ASSETS

Name / location	Character Area	Description
Stour House, 45 Kings Street, BH21 4BP	Historic core	Substantial detached property of character on the corner of King Street and Churchill close, set in mature gardens with established trees. It is cream rendered with Georgian sash windows, a grey slate roof and brick chimneys. The front of the house is symmetrical in design and of considerable architectural quality.
Toliva	Historic core	An attractive symmetrical brick-built villa that stamps a special identity on the adjacent green.
Riverside House	Historic core	Brick gables and a rendered front which may conceal a cob structure within. It has a corrugated iron roof, which on the basis of the remnant flashings on the chimney probably replaced a thatched roof. The modern windows also belie its age.
Cherry Cottage, Magnolia Cottage and the Victorian Methodist chapel	Historic core	The row of cottages that flank the north side of the 'Maypole' Market Place are of high townscape value. Magnolia House, a two-storey brick house built of brick under a slate roof and with formal sliding sash windows has a particularly elegant character. Similar materials are used in the Victorian Methodist chapel on the north side.
Old School	Historic core	The adjacent hall, formerly Mackrell's Charity School (1832), has good face brickwork and has retained its original Victorian windows and chimney stack on the rear (south) elevation.
Red Lion PH	Historic core	Traditional pub with light, colour washed walls and hanging baskets and window boxes makes a positive contribution to the character of the Conservation Area.
The Red House, 140 High Street and out buildings	Historic core	'The Red House', set back from the road in High Street displays the refined air of a stoutly-constructed 'rectory' type house of brick and slate has distinctive whitened window reveals which subtly enlivens the front facade. The house forms one of a small group of 19th century buildings that includes a barn and workshop that have been redeveloped for residential purposes.
Thatches (148) and 150 High Street, BH21 4BA (also known as 1 and 2 Red Cottages)	Historic core	This is a pair of semi-detached thatched cottages with brick whitewashed elevations. They have traditional cottage style front doors with Dorset square cottage style windows. They front directly onto the street, and are character properties in good condition that reflect the traditional cottage style housing of this part of the street scene.
72,74 and 76 High Street, BH21 4AZ	High Street	These are terraced cottages. 72 and 74 are of cob construction with Dorset square windows and traditional wooden front doors that open out onto the street. They have steeply sloping rooves which were possibly originally thatched. 76 is whitewashed brick built and is more modern.

Name / location	Character Area	Description
Sturminster Marshall First School, BH21 4AY	High Street	This was built in 1911 of red sandstone brick set within beautiful grounds with plenty of outdoor space. The school was relocated from the older building opposite the Church, to the larger property where it is now situated, as the village grew.
Joe's and Johnnies' Cottages, 61 and 63 High Street, BH21 4AS	High Street	One of a pair of brick 19 th century semi-detached cottages. The houses are set back from street behind front garden and hedges with veranda porch. Unique tall ornate chimneys. Brick built with half-timber frame gables. Name of cottage etched in wooden gable. Built by the Parke family after their son John Joseph died of influenza, aged 11. Baillie Leaze is of similar half-timbered design.
Ellen Cottage, 84 High Street, BH21 4AY	High Street	Detached house on the junction of Moor Lane and High street. The roof ridge is of ornate terracotta tile design. It used to be the home of the village midwife. Age of property: 1903.
65 and 67 (Maggie's Cottage) High Street, BH21 4AS	High Street	White rendered semi-detached cottages with a modern tile roof and small casement windows. The wooden front doors are built into a half hipped porch at the front of the property. Both cottages are adjacent to the entrance to Churchill close. They are set back from the road but are parallel to it and contribute significantly to the street scene. Age of property: 1699
1&2 Malwood, Moor Lane, BH21 4BD	Station Road	Semi-detached red brick cottages with interesting terracotta tiled ridge and slate rooves. They have wooden sash windows with stone casing and sills. Entrance from the properties is directly onto Moor Lane. Age of property :1909
71 and 73 (Moor View) High Street, BH21 4AT	High Street	These are Victorian semi-detached brick built properties connected by a dutch gable roof that is parallel to the street. They have tiled rooves, large chimneys and modern casement windows under an attractive brick arch. The veranda style front doors open onto a side drive.
Old Thatch, 92 High Street BH21 4AZ	High Street	Traditional white rendered thatched cottage with traditional small square windows and wooden cottage style front door, located adjacent to the street. It has been extensively renovated in recent years.
Locks Cottage and The Wing 96 and 96A High Street. BH21 4AN	High Street	Locks Cottage is attached to The Wing. Locks Cottage has white cob walls under a thatched roof with red brick chimneys. There are traditional Dorset square windows with a wooden front door which opens out directly onto the street. This door is under a thatched half hip porch. The walled garden lies to the side of the property.
Lower Dairy Farm, 102 High Street, BH21 4AZ	High Street	Detached property of white render under tile roof. Street frontage. Historic value as the village dairy farm within the perimeter of the village

Name / location	Character Area	Description
Firenze Cottage, 110 High Street, BH21 4AZ	High Street	This is a semi-detached cream rendered cottage that is set back but parallel to the street. It has an attractive arched front door and stone mullioned windows. Outside is a white stone showing the depth of flood water on 19 January 1980.
114 High Street, BH21 4BN	High Street	Originally a Dorset longhouse with walls made of cob, the house has been extensively renovated but still retains character. It is cream rendered with grey tiled roof and brick chimney. The windows are small with 4 square panes in each and there is a traditional wooden cottage style front door There is a 130ft garden to the rear. There are older cottage style properties adjacent to it.
116 and 118 High Street, BH21 4AZ	High Street	These are semi-detached white rendered cottages with street frontage, traditional wooden door and small paned casement windows. They have a slate roof and a shared chimney stack.
128 High Street	High Street	Site of mediaeval Court Leet dispensing justice for the manors of Coomb, Charborough and Moorcourt.
York House, 129 High Street, BH21 4AU	High Street	This is a well-proportioned and substantial brick built detached house built in 1900 with tiled roof and street frontage. It has sash windows with mullioned casing and sills. It is a significant contributor to the street scene.
Baillie Leaze, 8 Station Road, BH21 4AW	Station Road	Large, detached brick built house of 3 storeys with a clay tile roof and tall chimneys. There are half timbered gables to the front of the property – an unusual feature for houses in Dorset. It has sash windows, a veranda porch and an orangery. It was originally a substantial farm house owned by the Parke family (also of Henbury House) now set in 1/3 acre garden.
11 and 15 Station Road, BH21 4AW	Station Road	Semi-detached brick houses built over 3 storeys, with an ornate terracotta tiled ridge, sash windows, mullioned sills, attractive tiled front path, leading to a mullioned arch front porch. There is a half roof over the front ground floor bay windows. They significantly contribute to this part of the street scene
Churchill Arms, 45 High Street, BH21 4AS	Station Road	Purpose built public house built in yellow sandstone with a tarmac car park. It is on a slight rise set back from the road but clearly visible as a local landmark. It is opposite the entrance to the Baillie Gate Industrial estate which was once a railway station and cheese factory. One of a group of public houses built by Charles Godwin of Shroton Brewers in the local area to provide refreshment for railway travellers- an important reminder of the importance of the railway to the development of Sturminster Marshall. It is named after William Churchill Esq who gifted land to enable the Mackrell Charity to provide a school for the village.
Churchill Close, BH21 4BH	Churchill Close	Local authority houses built after the end of WW2 around a large green space for recreational use. The area later received an award for their design. They are a mixture of

Name / location	Character Area	Description
		terraced and semi-detached design with some bungalows in an annex off the main close. The properties were originally built for workers at the milk factory. The entrance to the close from Station Road is landscaped with attractive lime trees.
Baillie House, Poole Road. BH21 4AE	Blandford Road and Dullar Lane	Substantial detached house of character set in its own grounds with access to A350. It is red brick built with sash windows to the ground and first floors with dormer windows in the roof. The ornate chimneys are a feature of the building as is the veranda style front entrance. It was originally the old vicarage. It is the third vicarage on the site. The first vicarage was built by Henry Helm. The last vicarage burnt down in 1893
149 Church Street and Church Farm Cottage, Church Street, BH21 4BU	Countryside (near Sturminster Marshall)	A robust, early Victorian range of two storey buildings sited adjacent to the road at the northern end of the village. They are uniformly constructed of good quality brick under Welsh slate roofs and feature tall, well proportioned chimney stacks. The buildings are well preserved, retaining the original windows.
Golden Fox, Blandford Road BH21 4AQ	Countryside (near Sturminster Marshall)	Roadside country public house and restaurant with beer garden and car parking on the A350 on the outskirts of the village. Formerly known as the Ginger Fox and the Black Horse. It became the Golden Fox in 2016. It is brick built with light grey rendering with attractive painted stone cornices and steep weathered tiled roof. The windows upstairs are sash and downstairs, casement.
Newton Peveril Farm Newton Peveril BH21 4AN	Countryside (near Sturminster Marshall)	Formerly paired cottages, now a traditional 4/5 bedrooomed farmhouse in mature gardens, adjacent to buildings of a former dairy farm. It is accessed from A350. There are attractive terracotta features over first floor windows that are built into the gable. The house also has a traditional wooden porch and front door.
Millmoor House Kings Street BH21 4BN	Countryside (near Sturminster Marshall)	Individual style detached house of character set in substantial gardens located next to Millmoor Farm. It was originally two farm worker's cottages. Access is via bridge over the Winterborne river which is adjacent to a grade 2 listed packhorse bridge. The public path that runs along the western boundary of the property was the original route north to Blandford before the A350 was built.
Little Baillie, Dullar Lane, BH21 4AD	Countryside (near Sturminster Marshall)	Substantial brick built detached house, constructed in the 1930's with tiled roof. The house is set in its own private grounds. The site was chosen by Gerald Davies (Vicar of St Mary's). Once the home of the Bishop of Sherborne.
Henbury Cottages, Dorchester Road, BH21 3RW	Henbury	Semi-detached farm worker's cottages sitting alongside A31. They are cream rendered under a tiled roof and characteristic of the rural scene
Henbury Manor, Dorchester Road, BH21 3RL	Henbury	Destroyed by fire, rebuilt in 1990s. Substantial property set in 3 acres, of site of former manor, this iteration was built in the 1990s replacing as earlier property that was destroyed by fire. Access is from

Name / location	Character Area	Description
		A31 via a 300 metre driveway. Brick walls rendered in stucco. Slate roof. Sash windows to main building with dormer windows in the roof. Although recently built it is in traditional style and in keeping with the character of the area.
Vines Close House, Dorchester Road, BH21 3RW	Henbury	Re-modelled in 1866 as the Dower house for Henbury Hall. An attractive individual style substantial property. It has brick elevations under a clay tile roof with sash windows and a traditional wooden front door. There are 3 dormer windows in the roof and imposing chimneys with a Victorian conservatory. It is symmetrical in design. It was a residential care home until 1994 and is now a private dwelling bounded by a brick wall with views over farmland.
1 and 2 Coombe Farm Cottages BH21 3RR	Countryside (near Henbury)	Pair of late 19 th century semi-detached farm workers' cottages. Each with large gardens. Access to no.1 is via a private track. No.2 is accessed directly from A350. Typical Victorian farm workers' cottages – brick elevations with a tiled roof and brick chimney. Latticed windows.
Old Farm, Poole Road, BH21 3RR	Countryside (near Henbury)	The detached property is accessed via a track from A350. It is set in a farmyard surrounded by numerous outbuilding and barns. Rebuilt of brick in 19 th century, retaining only the stone plinth and chimney of an earlier building. Cast iron casement windows.
Forest Hill House Rushall Lane, BH21 3RT	Jubilee Cross	The property is of white rendered brick elevations under a tile roof with ornate chimneys. It is of unique design. There are shuttered windows and dormers in the roof. It is situated on a rise, looking South, with views over the Purbeck Hills. It is set in 15 acres of grounds and is accessed by a private drive from Rushall Lane. It was originally built as a private residence, then was used as a hospital in WW2 and later as a girls' school, before converting to a rest home in 1988.
Stoney Down Pottery (Jubilee Cottage), Rushall Lane, BH16 6AJ	Jubilee Cross	This Victorian detached house in sand coloured brick is set in its own gardens with potting shed to the rear. It was owned by Adrian Lewis Evans from 1957 until his death in January 2021 at 93. He was a potter using local clay and worked from his home.
Crumpets Farm, Crumpets Farm Drive, BH16 6AL	Countryside (near Jubilee Cross)	Large detached house set in substantial grounds with 2 outbuildings, bordering onto open countryside with far reaching views. It is brick built with steep tiled roof, south facing gable and modern chimney. Lattice windows.
West Almer Farm	Almer	Various traditional barns and farm buildings within Almer, which although of mixed architectural merit individually, are important as a group
Fortescue House	Almer	A well-proportioned modern house, with a symmetrical front and a central porch, facing the road.
17 and 18 Mapperton	Mapperton	A pair of small Victorian semi-detached villas of brick and slate, with a prominent central chimney stack

Name / location	Character Area	Description
Mapperton Farmhouse	Mapperton	Farmhouse with some cob walls but largely extended in the early nineteenth century with brick and stone. The entire roof, formerly thatched, is now tiled. Associated traditional barns to rear also of local importance
Thatch Cottage, Mapperton	Mapperton	A cob and thatch cottage
Dairy House, Mapperton	Mapperton	Nineteenth century brick and tiled house, symmetrically built with a simple, central doorway
29 and 30 Mapperton	Mapperton	Part brick and part rendered, under a half-hipped tiled roof, with dormer windows, facing away from the road
The Worlds End, Dorchester Road, Almer DT11 9EW	Countryside (near Almer and Mapperton)	This roadside public house and restaurant with garden and substantial car park, set in 2 hectares of land, is located on the A31 on the outskirts of Almer. It was once the oldest pub in Dorset with some parts dating back to 14 th century. However, it was largely destroyed by fire in 1991 but sympathetically rebuilt to retain its traditional characteristics. The freehold is part of the Charborough Park estate owned by Richard Drax. It is brick built, painted cream, with a thatch roof and traditional casement windows
The Old School	Countryside (near Almer and Mapperton)	

18. APPENDIX 6 – INDICATIVE HOUSING TARGET ASSESSMENT

18.1 LOCAL NEED ARISING FROM WITHIN THE VILLAGE:

18.1.1 Our household survey in 2020 showed:

- The majority of households (over 60%) were unlikely to look to move home in the next 5 – 10 years
- Of those that were looking to move, a significantly greater proportion said that they were looking to downsize to a smaller home, rather than needing a larger home. Overall the main demand from within the community appears to be for small (1 to 2 bedroom) bungalows and more modest-sized family homes, but also including some smaller (2 bedroom) starter homes.
- 19 households (about a third of those looking to move) were likely to relocate away from the parish. A further 12 households were likely to ‘split’ and create additional need (for example adult children looking to move out to form their own household). Whilst in theory this indicates that there would be sufficient homes to accommodate newly forming households, the homes that are vacated may not be of a suitable size and affordability.
- A further 43 households were aware of demand for housing from families not currently living in the parish, but who would like to move here. This indicates a degree of additional market demand (and competition) for new homes.

1.1 At the time of the housing needs assessment (late 2020), data from Dorset Council identified 10 households on the affordable housing register with a local connection and/or preference for Sturminster Marshall. By December 2022 this had risen to 13 confirmed households, with a further 4 pending assessment, mainly needing 2 bedroom homes, but including some need for 1, 3 and 4 bedroom properties. Similarly, some 12 of the responses (3.8%) of the household survey returns made in 2020 indicated that they would be looking for an affordable home (either rent from a Housing Association / Trust (affordable rented), part buy / part rent from a Housing Association / Trust (shared equity) or to buy at a discounted rate (affordable home ownership) in the next 5 – 10 years.

18.1.2 Whilst most people responding to our survey agreed that we need a broad range of homes and more affordable housing, many were against large developments due to strain on the current infrastructure. The general consensus view (expressed by the majority of respondents) was that continuing the current rate of development, of up to 5 homes a year on average, would be the most appropriate level of growth if suitable sites could be identified. This would certainly provide some flexibility to meet the changing housing needs of local residents.

18.1.3 Contact with local businesses and organisations during the preparation of this plan has not highlighted any significant need for population growth. Feedback from the limited number of businesses that responded to the business survey in the latter part of 2020 found only one business who said that they ‘sometimes’ had difficulty recruiting staff due to the lack of available affordable housing in the local area. Whilst two community organisations were concerned about their long-term future, this was as a result of changing population needs and priorities, and the availability of willing volunteers.

18.1.4 The main improvements to community facilities, suggested by local residents in response the Household Survey, related to outdoor sports and leisure facilities, and a health centre. More detail on this is covered in Section 11 of this plan. Whilst further housing could potentially provide developer / community infrastructure levy funding to pay for sports and leisure facilities, or help to provide a suitable space as part of any such development, it is highly unlikely that it would be sufficient to justify a new health facilities in the parish (particularly as such facilities need at least 10,000 patients to make economic sense).

18.2 PAST RATES / TAKE-UP OF DEVELOPMENT

18.2.1 Dorset Council monitor planning permissions and completions going back to 2011. We therefore have data on the amount of development that has taken place over the past 11 years (2011-22), which shows 36 new homes built during that period (an average of about 3 homes per annum, with up to 13 completions in any on year) and 34 new homes between the two Census periods. This compares to an increase of 53 dwellings in the previous Census period (2001 – 2011). Both of these would have been influenced by the limiting impact of Green Belt policies.

18.3 HOUSING TARGET CONCLUSIONS:

18.3.1 Based on the above analysis, it is clear that the indicative housing target included in the 2021 version of the draft Local Plan is significantly in excess of what would be a realistic assessment of local need, and as such would not be appropriate to formally adopt at this stage.

18.3.2 Local need appears to be primarily driven by affordable housing need, which currently stands at around 15 households. Additional open market housing may help provide stock more suited to the current population.

18.3.3 On this basis a housing target of at least 30 dwellings over 10 years (or 3 dwellings per annum) would seem an appropriate basis to plan for, with the aim to review this when the Local Plan target for this area, and whether sites may be released from the Green Belt, has been examined.

19. APPENDIX 7 - PUBLIC RIGHTS OF WAY REVIEW

KEY: BR = Bridleway FP = Footpath PP – Permissive Path UC = Unclassified Road

Ref	Status	Description	Comment
E53/1	FP	High Street to A31 Wimborne Road (part of Wareham Forest Way)	Ends at A31 leaving a walk of approximately 100m west on A31 to FP4. Path across fields prone to flooding in winter.
E53/2	FP	Moor Lane across Golf Course to join FP1	
E53/3	FP	Section of Moor Lane, along unclassified road, from fishing lakes gates to junction with FP1	Poorly maintained
E53/4	FP	A31 Wimborne Road, through Henbury Park via Wareham Forest Way to A350 and parish boundary	From end of FP1 walk along A31 to start of FP4. Path ends at A350 and requires users to walk north on A350 to join Wareham Forest Way along Coombe Almer road
E53/5	BR	Higher Coombe Farm to Sandy Lane along parish boundary	
E53/6	FP	A31 at Vines Close across fields to A350 opposite Baillie House	Cross Dorset Springs driveway entrance on A350 to FP8
E53/7	BR	Higher Coombe Farm to Dullar Lane on Wareham Forest Trail to parish boundary	
E53/8	FP	Station Road across fields to A350 east of Baillie House	Walk across Dorset Springs driveway entrance on A350 to FP6
E53/9	FP	From A350 opposite Baillie House to junction with FP8	
E53/10	BR	“Straight Mile” north to junction with BR16/BR17	Frequently flooded by Spring water.
E53/12	FP	From road at Almer old school towards Huish, crossing parish boundary	
E53/15	FP	From B3075 northwest towards Middle Buildings and crossing parish boundary	350m along B3075 to FP15 which otherwise make a link through to Spetisbury.
E53/16	BR	From A350/Green Lane junction passing south of Westley Woods to B3075	350m along B3075 to FP15 which otherwise make a link through to Spetisbury.
E53/17	BR	Junction BR10/BR16 to A350 Via Westley Farm and Moorcourt Farm	Ending at A350 reduces its amenity value. But if Trailway is extended then this would provide another access onto it where it crosses the old railway track.
E53/18	BR	From Kings Street, via Millmoor and Green Lane to A350 opposite EP16	At Green Lane Cottage OS map and Dorset Explorer indicate that bridle way has been diverted away from original route. Current route is passable and could be formalised.
E53/19	FP	Market Place to Back Lane (Jeannette’s Lane)	

Ref	Status	Description	Comment
E53/20	FP	High Street and via old railway track bed to Newton Road	Ramp at Newton Road end is too steep for disability access
E53/21	BR	Along southern edge off Great Cool Wood to meet road from Mapperton	Connects to paths in neighbouring parishes around Great Coll Wood and ancient Combes Ditch
D40704	UC	Long Drove (Path from Mill Lane near White Mill Bridge round to Moor Lane behind Sturminster Marshall Golf Club)	Often overgrown / blocked by tree trunks and a farm roller which makes it impassable for mobility scooters also - but if kept clear this could encourage recreational use by motorcyclists etc to the detriment of walkers. Many residents in our consultation asked for it to be cleared to open up the possibility of more circular routes.
D40707	UC	Farm track north from Mapperton to parish boundary where it becomes a bridleway	Farm track with no onward connection for vehicles – concerns that its classification encourages off-road motor vehicle users to drive to the boundary and over into Spetisbury where they don't have any rights, and is a means of access and escape for rural crime.
D40709	UC	From Straight Mile to Newton Peveril.	We are not aware of any problems on this route
D40934	UC	Old Market Road	Highlighted as a 'Quiet Road' on the Core Strategy Policies Map.
C116	C	Rushall Lane	Highlighted as a 'Quiet Road' on the Core Strategy Policies Map.
	PP	From Elm Gardens off the High Street, through Bartons Ground to join Footpath FP1	Permissive path
	PP	Across field from Railway Drive to Newton Road	Permissive path

